

JVC

SERVICE MANUAL

MODEL R-X500B

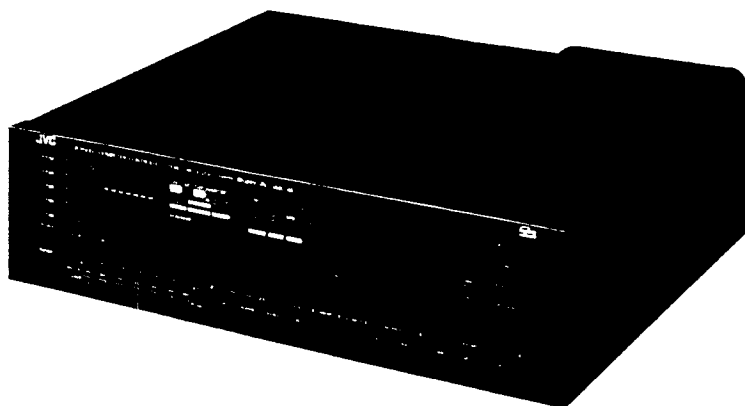

Contents

Safety Precautions	1-1	6. Block Diagram/Wiring Connection	1-13
1. Specifications	1-2	7. R-X500B Schematic Diagram	
2. Names of Parts and Their Functions	1-3	7-(1) R-X500B Tuner Section	1-14
3. Technical Explanations		7-(2) R-X500B Logic Section	1-15
3-(1) Terminal Layout Diagram	1-7	7-(3) R-X500B Amplifier Section	1-16
3-(2) Interior Block Diagram	1-7	8. Servicing Method for AWG #20	
3-(3) Explanation of Each Terminal	1-8	Wires with Clamping Terminals	1-17
3-(4) Power Supply Switching Circuit	1-9	9. Handling precautions of LCD panels	1-18
4. Removal Procedures	1-10		
5. Adjustment Procedures			
5-(1) FM/AM Tuner P.C. Board	1-11		
5-(2) Power Amplifier P.C. Board	1-12		

Safety Precautions

1. The design of this product contains special hardware, many circuits and components specially for safety purposes.

For continued protection, no changes should be made to the original design unless authorized in writing by the manufacturer. Replacement parts must be identical to those used in the original circuits. Service should be performed by qualified personnel only.

2. Alterations of the design or circuitry of the product should not be made. Any design alterations or additions will void the manufacturer's warranty and will further relieve the manufacturer of responsibility for personal injury or property damage resulting therefrom.
3. Many electrical and mechanical parts in the product have special safety-related characteristics. These characteristics are often not evident from visual inspection nor can the protection afforded by them necessarily be obtained by using replacement components rated for higher voltage, wattage, etc. Replacement parts which have these special safety characteristics are identified in the parts list of Service manual. Electrical components having such features are identified by shading on the schematics and by (Δ) on the parts list in Service manual. The use of a substitute replacement which does not have the same safety characteristics as the recommended replacement part shown in the parts list in Service manual may create shock, fire, or other hazards.
4. The leads in the products are routed and dressed with ties, clamps, tubings, barriers and/or the like to be separated from live parts, high temperature parts, moving parts and/or sharp edges for the prevention of electric shock and fire hazard.

When service is required, the original lead routing and dress should be observed, and they should be confirmed to be returned to normal, after re-assembling.

5. Leakage current check

(Safety for electrical shock hazard)

After re-assembling the product, always perform an isolation check on the exposed metal parts of the Products (antenna terminals, knobs, metal cabinet, screw heads, headphone jack, control shafts, etc.) to be sure the product is safe to operate without danger of electrical shock.

Do not use a line isolation transformer during this check.

- Plug the AC line cord directly into the AC outlet. Using a "Leakage Current Tester", measure the leakage current from each exposed metal part of the cabinet, particularly any exposed metal part having a return path to the chassis, to a known good earth ground. Any leakage current must not exceed 0.5 mA AC (r.m.s.).

- Alternate check method.

Plug the AC line cord directly into the AC outlet. Use an AC voltmeter having 1,000 ohms per volt or more sensitivity in the following manner. Connect a 1500 Ω 10 W resistor paralleled by a 0.15 μ F AC-type capacitor between an exposed metal part and a known good earth ground.

Measure the AC voltage across the resistor with the AC voltmeter.

Move the resistor connection to each exposed metal part, particularly any exposed metal part having a return path to the chassis, and measure the AC voltage across the resistor. Now, reverse the plug in the AC outlet and repeat each measurement. Any voltage measured must not exceed 0.75 V AC (r.m.s.). This corresponds to 0.5 mA AC (r.m.s.).

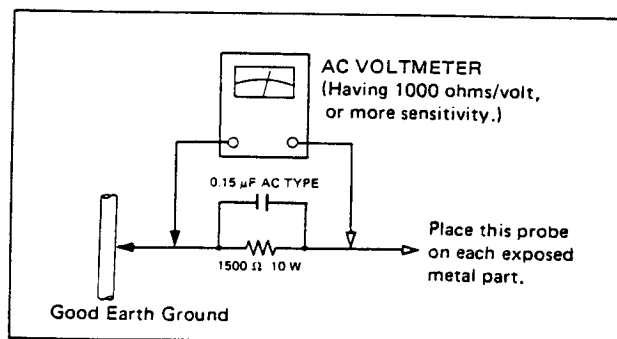

CHECKING YOUR LINE VOLTAGE (Except for U.S.A., Canada, Australia, U.K. and Continental Europe.)

Before inserting the power plug, please check this setting to see that it corresponds with the line voltage in your area. If it doesn't, be sure to adjust the voltage selector switch to the proper setting before operating this equipment. The voltage selector switch is located on the rear panel.

CAUTION Before selecting the "Voltage selector switch" to proper voltage disconnect the power plug.

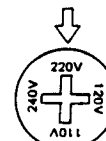

1. Specifications

AMPLIFIER SECTION

RMS Power : 100 watts per channel, min. RMS, both channels driven, into 8 ohms from 20 Hz to 20 kHz, with no more than 0.007 % total harmonic distortion.

110 watts per channel, min. RMS, both channels driven, into 8 ohms from 40 Hz to 20 kHz, with no more than 0.2 % total harmonic distortion.

105 watts per channel, min. RMS, both channels driven, into 8 ohms at 1 kHz with no more than 0.003 % total harmonic distortion.

110 watts per channel, min. RMS, both channels driven, into 8 ohms at 1 kHz with no more than 0.7 % total harmonic distortion.

Total Harmonic Distortion : 0.003% at 100 watts (1 kHz, 8 ohms)

Intermodulation Distortion : 0.007% at 100 watts

Damping Factor : 45 at 8 ohms, 1 kHz

Input Sensitivity/Impedance

PHONE (MM) : 2.5 mV/47 kohms

(MC) : 250 μ V/100 ohms

TAPE PLAY/ : 240 mV/50 kohms

DAD/AUX

Recording Output : 240 mV

Frequency Response

PHONE (RIAA) : ± 0.5 dB (20 Hz - 20 kHz)

Equalization

TAPE PLAY : -1 dB (5 Hz - 50 kHz)

DAD/AUX

S.E.A. Graphic

Equalizer Center : 63 Hz, 160 Hz, 400 Hz, 1 kHz, 2.5 kHz,

Frequencies : 6.3 kHz, 16 kHz

Control Range : ± 10 dB

Loudness Control : +6 dB at 100 Hz

(Volume control at -30 dB position) : +4 dB at 10 kHz

Signal to Noise Ratio

PHONE (MM) : 80 dB (66 IHF) 66 dB (DIN)

80 dB (78 IHF)

(Rec out)

TAPE PLAY/ : 100 dB (66 IHF) 67 dB (DIN)

DAD/AUX : 77 dB (78 IHF)

FM TUNER SECTION

	'78 IHF	DIN (for Europe)
Tuning Range	: 87.9 MHz-107.9 MHz	87.5 MHz-108.0 MHz
Usable Sensitivity	: Mono 10.3 dBf 0.9 μ V/75 ohms 1.8 μ V/300 ohms	(S/N 26 dB) 1 μ V/75 ohms 2 μ V/300 ohms
50 dB Quieting Sensitivity	: Mono 14.8 dBf (3.0 μ V/300 ohms) Stereo 38.3 dBf (45 μ V/300 ohms)	-
S/N 46 dB Stereo Sensitivity	: -	Stereo 23 μ V/75 ohms Stereo 46 μ V/300 ohms
Signal to Noise Ratio (at 98 MHz, 80 dBf)	: Mono 82 dB Stereo 73 dB (A-net.)	Mono 74 dB Stereo 65 dB (weighted)
Total Harmonic Distortion	: Mono 0.08 % Stereo 0.1 %	Mono 0.08 % Stereo 0.08 %
1 kHz Frequency Response	: 30 Hz - 15 kHz, +0.5 dB, -0.8 dB	
Capture Ratio	: 1.5 dB	1.0 dB
Alternate Channel Selectivity	: 75 dB, ± 400 kHz	60 dB, ± 300 kHz
Image Response Ratio	: 80 dB at 98 MHz	
IF Response Ratio	: 100 dB at 98 MHz	
Stereo Separation	: 50 dB at 1 kHz	45 dB at 1 kHz

AM TUNER SECTION

	'78 IHF	DIN (for Europe)
Tuning Range		
Channel space	: 522 kHz-1611 kHz 9 kHz	522 kHz-1611 kHz
Channel space	: 530 kHz-1710 kHz 10 kHz	
Sensitivity	: 250 μ V/m at 1000 kHz 30 μ V at 1000 kHz	250 μ V/m at 999 kHz 30 μ V at 999 kHz
Signal to Noise Ratio (100mV/m)	: 50 dB at 1000 kHz	50 dB at 999 kHz
Selectivity	: 38 dB, ± 10 kHz at 1000 kHz	35 dB, ± 9 kHz at 999 kHz

Design and specifications subject to change without notice.

Power Specifications

Areas	Line Voltage & Frequency	Power Consumption
U.S.A., Canada	AC 120 V, 60 Hz	350 watts, 450 VA
Continental Europe	AC 220 V \sim , 50 Hz	250 watts
U.K., Australia	AC 240 V \sim , 50 Hz	250 watts
Other Areas	AC 110/120/220/240 V \sim , Selectable, 50/60 Hz	300 watts

Dimensions and Weight

Height	Dimensions		Weight
	Width	Depth	
117 mm (4-5/8")	435 mm (17-1/8")	370 mm (14-9/16")	Net 9.3 kg (20.5 lbs)

2. Names of Parts and Their Functions

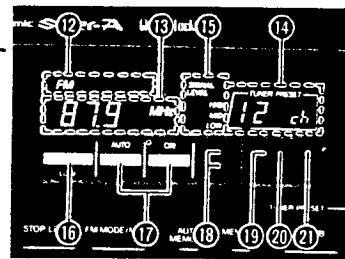
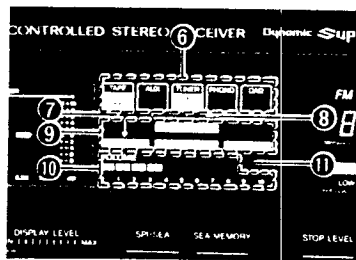
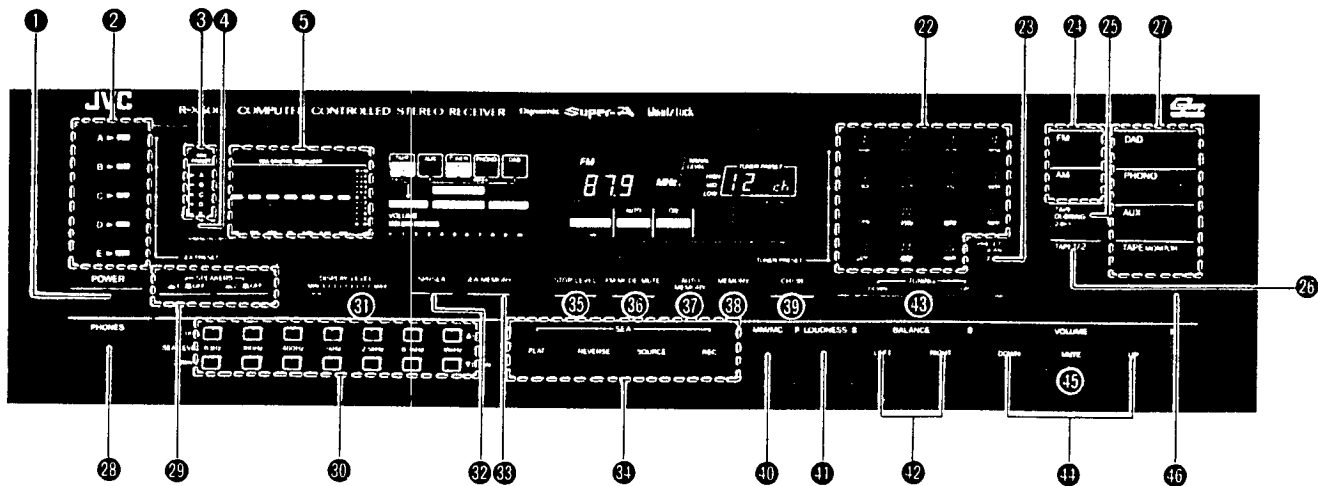

- ① **POWER switch**
Press to turn the power on. To turn the power off, press again.
- ② **SEA PRESET switches**
Press to store the SEA pattern in memory or recall the preset SEA pattern corresponding to the switch pressed. Up to 5 SEA patterns can be stored in memory; press the SEA PRESET switches while the MEMORY indicator is lit.
- ③ **SEA PRESET pattern indicator**
The square corresponding to the SEA PRESET switch pressed lights to show which pattern is being used.
- ④ **MEMORY indicator**
This lights for about 5 seconds when the SEA MEMORY switch is pressed to show it is ready to store in memory the SEA pattern set by the SEA LEVEL UP/DOWN controls.
- ⑤ **SPECTRO PEAK INDICATOR/SEA GRAPHIC EQUALIZER level indicator**
This display doubles as a SPECTRO PEAK INDICATOR and SEA GRAPHIC EQUALIZER-level indicator and is switched between two indications when the SPI/SEA switch is pressed.
SPECTRO : The output signal levels are analyzed for PEAK INDICATOR 7 frequency bands whose center frequencies are identical to those of the 7 S.E.A. controls.
 This SPECTRO PEAK INDICATOR shows the output signal level in each frequency band. For easy visibility, the indicators are designed so that their response time is faster when rising and slower when decaying.
SEA : The bar moves up and down in response to the pressing of the corresponding SEA LEVEL controls to show the SEA level in each frequency band.

- Notes:**
- The SEA GRAPHIC EQUALIZER level indicator is shown for about 5 seconds after the power is applied.
 - The SEA GRAPHIC EQUALIZER level indicator is shown for about 5 seconds when the SEA LEVEL controls, SEA PRESET switches, SEA FLAT switch, SEA REVERSE switch, SEA SOURCE switch, SEA MEMORY switch are pressed even if set to the SPECTRO PEAK INDICATOR display.
 - The SEA GRAPHIC EQUALIZER level indicator is always shown when this indication is selected by the SPI/SEA switch.
- ⑥ **Pictorial source display**
This lights according to the source selected.
 - ⑦ **TAPE 1 and 2 indicators**
Show the setting of the TAPE 1/2 switch.
 - ⑧ **MM/MC indicator**
MM or MC is shown when the MM/MC (cartridge select) switch is pressed.
 - ⑨ **Signal flow chart**
This shows the signal flow and if the SEA compensation is performed, etc.

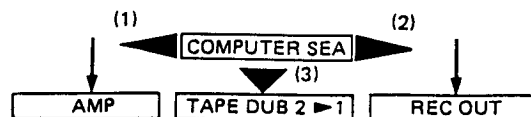

Note:

- (1) When the SEA SOURCE switch is pressed, ◀ lights to show that the SEA is applied to the signals output from the speakers or the headphones.
- (2) When the SEA REC switch is pressed, ▶ lights to show that the SEA is applied to the signals output from the REC OUT terminals.
- (3) When the SEA REC switch is pressed during TAPE DUBBING, ▼ lights to show that the SEA is applied to the signals output from the TAPE REC 1 terminals.

10 VOLUME/BALANCE indicator

This indicator doubles as the VOLUME and BALANCE indicator. When the VOLUME controls are pressed, VOLUME lights and this indicator shows the level of the sound to the speakers or headphones. When the BALANCE controls are pressed, BALANCE, center bar, L and R light and the balance between the right and left speakers is shown. This BALANCE indicator is shown for about 5 seconds and then the VOLUME indicator is shown. When the MUTING switch is pressed, this indicator flickers.

11 LOUDNESS indicator

When the LOUDNESS switch is pressed to set to on, LOUDNESS lights; pressing it again makes the indicator go out.

12 FM/AM indicator

FM is displayed during FM reception and AM during AM reception.

13 Frequency indicator

The turned-in frequency is displayed digitally. Four digits (kHz) are displayed during AM reception and five digits (MHz) (for Europe, U.K., Australia and other countries) or four digits (MHz) (for U.S.A. and Canada) are displayed during FM reception.

14 SIGNAL STRENGTH/TUNER PRESET indicator

This indicator doubles as the dB signal strength indicator and the tuner preset indicator to show the channel number of the preset station.

This indicator can be switched between the two display modes by pressing the CH/dB switch.

Notes:

- 0 dB corresponds to 1 $\mu\text{V}/75$ ohms in FM and 1 $\mu\text{V}/\text{m}$ in AM.
- The indication is shown in 5 dB steps.
- The optimum signal strength is more than 40 dB for FM mono, more than 60 dB for FM stereo and 70 dB for AM. If the signal is too weak or too strong, this display may not indicate the correct value.
- Even if the dB display mode is set by pressing the CH/dB switch, the CH indication is displayed and maintained when the station select buttons are pressed. When the TUNING button is pressed, the 0 dB indication is displayed.
- If a broadcast is received by preset tuning and then the CH/dB switch is pressed so that the dB indication is displayed before switching the power off, the CH indication will be displayed when the power is switched on again.

15 SIGNAL LEVEL indicator

This is used in tuning to both FM and AM broadcasts. The signal strength is shown at three levels.

Note:

- The three levels —, low, mid and high — correspond to the signal strength in dB as shown below.

16 STOP LEVEL indicator

This indicator shows HIGH or LOW according to the setting of the STOP LEVEL switch.

17 FM MODE/FM MUTE indicator

This indicator shows AUTO/ON or MONO/OFF according to the setting of the FM MODE/MUTE switch.

18 STEREO/QSC indicator

STEREO: When an FM stereo broadcast is being received, this indicator lights. When the MODE indicator shows MONO even if an FM stereo broadcast is received, this indicator will not light; press the FM MODE/MUTE switch so that AUTO is shown.

QSC: When a signal strength of an FM stereo broadcast is low, this indicator lights and the QSC (Quieting Slope Control) circuit is switched on to reduce noise.

Note:

- Since the STEREO and QSC is automatically set according to the signal strength, if the signal strength changes, re-tune.

19 AUTO MEMORY indicator

Lights when the AUTO MEMORY switch is set to on.

20 MEMORY indicator

Lights for about 5 seconds when the MEMORY switch is pressed to on or for 1 second when the frequency is stored in memory during auto memory.

21 PRESET SCAN indicator

Lights when the PRESET SCAN switch is pressed to on.

22 Station select buttons

These buttons are used to select one of the preset stations or to store the frequency in the memory of an individual channel. When one of these buttons is pressed, the channel number is shown by the TUNER PRESET indicator.

If one of these buttons is pressed when the MEMORY switch is pressed in, the frequency which is being received will be stored in memory.

Each of the station select buttons can be used for one FM station and one AM station.

If you change the mode from radio reception to any other mode including power-off and back to radio reception, the station previously selected with the station select buttons is tuned to again.

23 PRESET SCAN switch

This switch permits the scanning of preset stations. When this switch is pressed, the PRESET SCAN indicator lights and channel 1 is tuned in, then this channel number flashes for about 5 seconds. The following channels are shown in the same way. When the desired station is received, pressing this switch stops scanning so that the R-X500B remains tuned to the station. After 15 stations (FM/AM) have been scanned, the frequency received originally before preset scanning is tuned to.

24 Tuner band switches

FM switch: Press to switch on the FM tuner section.

AM switch: Press to switch on the AM tuner section.

25 TAPE DUBBING switch

Press in to dub from TAPE-2 to TAPE-1. Press again to record from records or radio broadcasts or the source connected to the DAD or AUX terminals.

Note:

- Dubbing from TAPE-1 to TAPE-2 is not possible.

26 TAPE 1/2 switch

Press to listen to the tape deck connected to the TAPE-1 or TAPE-2 terminals after pressing the TAPE MONITOR switch. The corresponding indicator will light in the display.

- 27 Source selector**
DAD switch : Press to hear or record sound from the source connected to the DAD terminals.
PHONO switch : Press to hear or record sound from the turntable connected to the PHONO terminals.
AUX switch : Press to hear or record sound from the source connected to the AUX terminals.
TAPE : Press to listen to the tape deck connected to the TAPE-1 or TAPE-2 terminals.
MONITOR switch : Release this switch to hear the source selected by the other source select switches.
 Use the TAPE 1/2 switch to switch between TAPE-1 and 2.
- 28 Headphone jack (PHONES)**
 Flip down the cover and plug stereo headphones into this jack for private listening and to monitor recordings. See page 33. If you want to listen to sound from the headphones only, press the SPEAKERS switches to OFF.
- 29 SPEAKERS switches**
SPEAKERS-1 : Press to switch the speakers connected switch to the SPEAKERS 1 terminals on or off.
SPEAKERS-2 : Press to switch the speakers connected switch to the SPEAKERS 2 terminals on or off.
- 30 SEA LEVEL controls (UP/DOWN)**
 The graphic equalizer of the R-X500B divides the audio spectrum into 7 frequency bands with center frequencies from 63 Hz to 16 kHz at intervals of 4/3 octave. When the SEA level is set to '0' (center position of the SEA GRAPHIC EQUALIZER level indicator), the frequency response is flat. The response in each band can be varied by ± 10 dB by pressing the UP or DOWN SEA LEVEL control. The controls for different frequency bands can be pressed at the same time and holding them pressed changes the level continuously.
63 Hz : Raise to emphasize the very low bass response of organs, drums, and contrabass. It produces stable and solid sound with emphasis and eliminates the unclear sound response of low frequencies with de-emphasis.
160 Hz : Emphasize to obtain a more expanded low frequency sound. De-emphasize to eliminate unclear sound caused by large spaces in listening rooms.
400 Hz : This frequency range is the base on which music is constructed. Emphasize to really put a punch in to your music.
1 kHz : Most effective in emphasizing or de-emphasizing the human voice. Emphasize to cause the vocalist to be brought to the foreground, or de-emphasize for causing it to recede into the background.
2.5 kHz : This frequency stimulates the human ear. If the music sounds hard or metallic, de-emphasize.
6.3 kHz : Boost to add clarity to winds and strings. This frequency band varies the tonal expression, influencing the subtleties of the music.
16 kHz : Boosting this frequency range properly adds to the delicacy of highs, with cymbals and triangles resounding in a more ear-pleasing manner, and provides a feeling of extension. This frequency band can also be used to compensate for cartridge response since most moving-magnet cartridges have their resonance peaks in the frequency range from 10 kHz to 20 kHz.
- 31 DISPLAY LEVEL control**
 Adjusts the relative display position on the SPECTRO PEAK INDICATOR so that even low-level signals can be displayed in an easy-to-see position. This control has no effect on the output sound level.
- 32 SPI/SEA switch**
 Press to switch the indication between the SPECTRO PEAK INDICATOR and SEA GRAPHIC EQUALIZER level indicator.
- 33 SEA MEMORY switch**
 Press this switch and the MEMORY indicator lights for about 5 seconds. In this period, press one of the SEA PRESET switches to store the SEA pattern in memory.
- 34 SEA switches**
FLAT switch : Press this switch for a flat response.
REVERSE switch : Press this switch to reverse the characteristics.
SOURCE switch : Press this switch to listen to the source with SEA-compensation.
REC switch : Press this switch to record tapes with the added effect of the S.E.A. graphic equalizer.
- Note:**
 • The settings of the SOURCE and REC switches are shown in the signal flow chart 9.
- 35 STOP LEVEL switch**
 This is used to switch over the sensitivity of the receiver between high and low; it determines the strength of broadcast signals at which the scan tuning stops. It is effective during the auto memory and auto tuning.
- Note:**
 • This stop level is related to the SIGNAL LEVEL indicator 15.
 The HIGH stop level corresponds to higher than MID level signals and the LOW stop level corresponds to LOW level signals.
- 36 FM MODE/MUTE switch**
 Press this switch so that AUTO of FM MODE and ON of FM MUTE light in the display for normal FM reception for automatic elimination of interstation noise. When receiving a weak or noisy FM stereo broadcast, press this switch so that MONO of FM MODE and OFF of FM MUTE in the display light; the broadcast will be heard in mono but the clarity of reception will be improved.
- 37 AUTO MEMORY switch**
 Press this switch to scan and preset broadcasts automatically. The dB indication is shown and the received frequency changes from the lower frequency limit. After this, if a broadcast is tuned in, its signal strength is shown in dB for 1 second and channel number 1 flickers for 3 seconds. If this broadcast is not required to be stored in memory, press this switch within 4 seconds; the dB indication is shown and auto memory function starts again. If it is required, the MEMORY indicator and channel number light together and its frequency is stored in memory channel 1. Then the dB indication is shown again and up-scanning restarts. The same function is performed for the remaining channels. When the frequency reaches the upper limit, the auto memory function stops and the channel number in which the highest frequency in memory is shown. If there is no broadcast to be tuned to, the upper limit frequency is shown with dB displayed instead of the channel number. When all channels have frequencies stored in them, the last frequency in memory is tuned to and its channel number is shown. During this operation, if any of the band switches is pressed, this function stops and the broadcast being heard is still received if its band is the same as that of the switch pressed, this function stops and the broadcast being heard is still received if its band is the same as that of the switch pressed while the last channel is tuned to if its band is different from the switch pressed.
- Note:**
 • Do not press the PRESET SCAN switch or the TUNER PRESET switch of the remote control during auto memory for stable operation.
 Do not perform the auto memory function when the source selector is set to other than TUNER.

- 38 MEMORY switch**
 Press this switch and the MEMORY indicator will light to show it is ready to receive a memory setting. Pressing the station select button while the MEMORY indicator is lit (for about 5 seconds) makes it possible to store the station in the specified memory. At this time, the channel number is shown in the display.
- 39 CH/dB switch**
 Press to select the channel indication or dB indication. If one of the station select buttons is not pressed beforehand, only the dB indication is shown and this switch has no effect. During auto memory and preset scanning, this switch does not work.
- 40 MM/MC switch**
MM: Press this switch so that MM is shown on the display when using an MM cartridge or an MC cartridge with an output of more than 0.5 mV.
MC: Press this switch so that MC is shown on the display when using an MC cartridge with an output of less than 0.5 mV.
- 41 LOUDNESS switch**
 Press to compensate for the ear's different sensitivity to sound when you are listening at low volumes.
- 42 BALANCE controls (LEFT, RIGHT)**
 Use to adjust the balance between the left and right speakers. Press the LEFT button once to adjust the balance to the left by one step and the RIGHT button to adjust to the right. Holding them pressed changes the balance continuously. The BALANCE indicator is shown on the display.
- 43 TUNING UP/DOWN button**
 When this button is pressed, the dB indication is shown.
DOWN: Press to tune to lower frequencies.
UP: Press to tune to higher frequencies.
- Manual tuning**
 Tapping either sides changes the frequency in single steps of 9 or 10 kHz in AM, 50 or 100 kHz in FM.
- Auto tuning**
 Holding either side of button pressed for more than 0.5 second and then releasing it starts auto tuning; when a broadcast is received, tuning will stop. But if either side of button is kept held in, scanning continues even when a broadcast is received. In auto tuning, pressing either side of buttons stops scanning.
- Note:**
 • Tapping the button stops changing the frequency when the upper or lower frequency is reached, while, in auto tuning the frequency changes in the opposite direction.
- 44 VOLUME controls (UP/DOWN)**
 Adjust the volume of speakers or headphones. Press the UP button once to increase the volume by one step and the DOWN button to decrease it by one step; this level is shown by the VOLUME indicator in the display. Holding these buttons pressed changes the volume continuously.
- 45 MUTING switch**
 Press to mute the sound instantaneously, and the VOLUME/BALANCE indicator flickers. Use this switch when answering the telephone, for example. Pressing again returns the volume to that adjusted with the VOLUME/BALANCE controls.
- 46 Reception window for remote control**
 Receives signals from the wireless remote control unit.

Note:

- Do not block this window which receives the signal from the remote control.

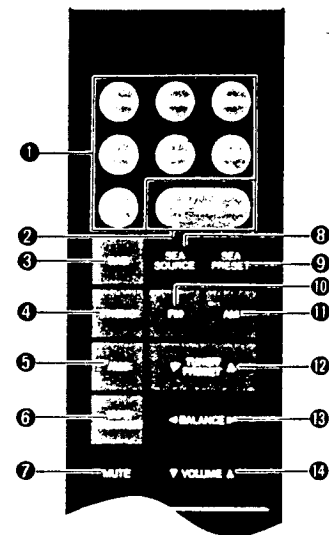

HOW TO USE THE REMOTE CONTROL UNIT

Using the provided remote control unit allows you to control the principal functions of the R-X500B. With this remote control, you can obtain the optimum reception condition from your listening position.

- 1 SEA frequency band select buttons**
 Use to select the frequency band to change the SEA level.
- 2 SEA control**
 Press the ▲ side to increase the level and ▼ side to decrease it after selecting the frequency bands with the SEA frequency band select buttons.
- 3 DAD switch**
 Functions are the same as the DAD switch on the R-X500B.
- 4 PHONO switch**
 Functions are the same as the PHONO switch on the R-X500B.
- 5 AUX switch**
 Functions are the same as the AUX switch on the R-X500B.
- 6 TAPE MONITOR switch**
 Functions are the same as the TAPE MONITOR switch on the R-X500B.
- 7 MUTE switch**
 Functions are the same as the MUTE switch on the R-X500B.
- 8 SEA SOURCE switch**
 Press this switch to listen to source with SEA-compensation.
- 9 SEA PRESET switch**
 Press to call up a preset SEA pattern. When one of the preset SEA patterns is set (the SEA PRESET pattern indicator is lit), each time this switch is pressed, preset SEA patterns are called up in order from the next. When preset SEA pattern is not set, pressing this switch calls them up in order from preset SEA pattern A.
- 10 FM switch**
 Press to switch on the FM tuner section.
- 11 AM switch**
 Press to switch on the AM tuner section.
- 12 TUNER PRESET switch**
 Press the ▲ side to scan the preset stations in the direction of increasing channel numbers and the ▼ side to scan in the opposite direction. Use to tune to the desired broadcast.
- 13 BALANCE control**
 Press the ► side to adjust the balance to the right and the ◀ side to adjust to the left.
- 14 VOLUME control**
 Press the ▲ side to increase the volume and the ▼ side to decrease it.

Note:

- When the remote control is operated too near the receiver during AM reception, noise may occur.

Technical Explanations

When the various LSI's adopted on this model, explanations are made in this Section especially on the two types of LSI's related to SEA control by the computer. These two LSI's are LC7520 (Symbol No. IC 503) and LC7560 (Symbol No. IC 441).

Terminal Layout Diagram

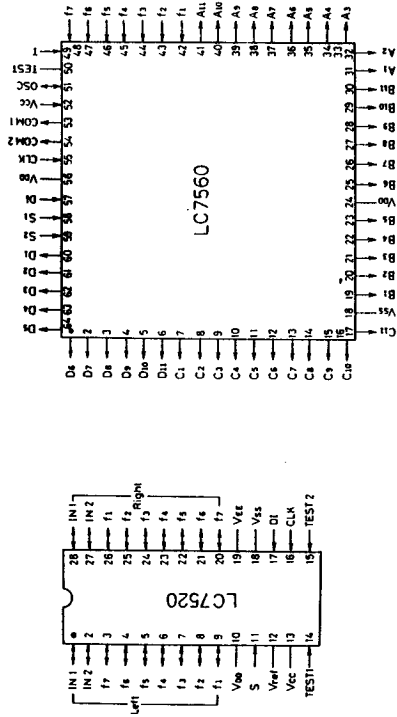

For Service Manuals Contact
MAURITRON TECHNICAL SERVICES
 8 Cherry Tree Rd, Chinnor
 Oxon OX9 4QY
 Tel: 01844-351694 Fax: 01844-352554
 Email: enquiries@mauritron.co.uk

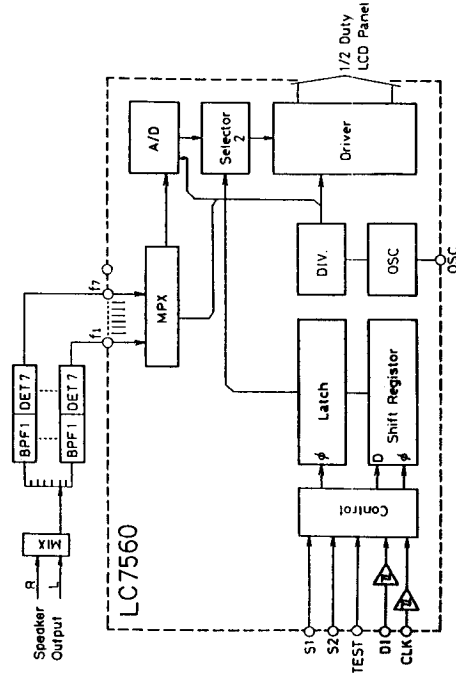

3-(3) Explanation of each terminal

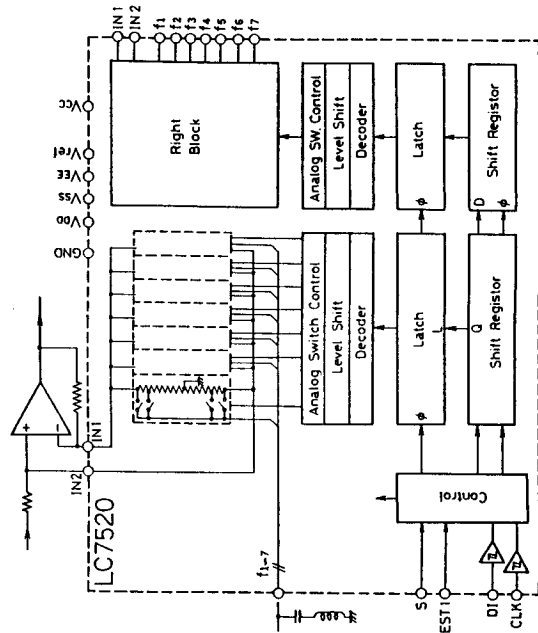

LC7520 (Graphic Equalizer) C-MOS LSI, 7 bands, right-side/left-side independent, ± 2 db step, ± 10 db variable

Interior Block Diagram



Name	Terminal No.	Terminal type	Explanation
VDD	10	—	Power supply terminal, +18V Power supply for voice signals
Vref	12	—	Power supply terminal, +13V Power supply for logic drive
Vss	18	—	Power supply terminal, 0V
VEE	19	—	Power supply terminal, -18V Power supply for voice signals
DI	17	—	Terminal for data input from CPU Schmitt inverter type
CLK	16	—	Terminal for clock input from CPU Schmitt inverter type
GND	—	—	Voice-signal system GND
IN1	1, 28	—	Input terminal for voice signals IN1 to be connected to OP amplifier inversion input
IN2	2, 27	—	IN2 to be connected to OP amplifier noninversion input Provided both on right side and on left side
f1 ~ f7	9 ~ 3 26 ~ 20	—	Connection terminal for band filter f1 ~ f7 x right side/left side Total 14 terminals
S	11	—	Select terminal when 2 chips are used Key code: FD under "f" input Key code: FC under "g" input

LC7560 (LCD Display Driver) C-MOS LSI, 7 bands, ±2 db step, 11-point display

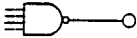
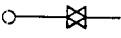
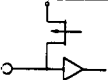
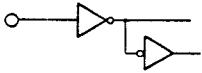
Name	Terminal No.	Terminal type	Explanation														
VDD	24 56	—	Power supply terminal, +13V Power supply for A/D conversion														
Vcc	52		Power supply terminal, +5V Power supply for logic drive														
Vss	18		Power supply terminal, 0V														
DI	57		Terminal for data input from CPU Schmitt inverter type														
CLK	55		Terminal for clock input from CPU Schmitt inverter type														
COM1 COM2	53 54		Output terminal to LCD common														
A ₁ ~ A ₁₁	31 ~ 41		Output terminal to LCD segment For bands f ₁ and f ₂														
B ₁ ~ B ₁₁	19 ~ 30		Output terminal to LCD segment For bands f ₃ and f ₄														
C ₁ ~ C ₁₁	7 ~ 17		Output terminal to LCD segment For bands f ₅ and f ₆														
D ₁ ~ D ₁₁	60 ~ 64 1 ~ 6		Output terminal to LCD segment For band f ₇ and total display														
f ₁ ~ f ₇	42 ~ 48		Input terminal for voice signal detection output														
T	49		Input terminal for total display Inputs signal detection output														
OSC	51		Open-drain-type output buffer Connection terminal of exterior-mounted CR for oscillator														
S1	58		Select terminal when a plural number of chips is used (max. 4 chips)														
S2	59			<table border="1"> <thead> <tr> <th>S1</th> <th>S2</th> <th>Key Code</th> </tr> </thead> <tbody> <tr> <td>1</td> <td>1</td> <td>FB</td> </tr> <tr> <td>0</td> <td>1</td> <td>FA</td> </tr> <tr> <td>1</td> <td>0</td> <td>F9</td> </tr> <tr> <td>0</td> <td>0</td> <td>F8</td> </tr> </tbody> </table>	S1	S2	Key Code	1	1	FB	0	1	FA	1	0	F9	0
S1	S2	Key Code															
1	1	FB															
0	1	FA															
1	0	F9															
0	0	F8															

3-(4) Power Supply Switching Circuit

- When the load impedance exceeds 7 ohms, or when the output is small even under 7 ohms, Q804, Q803, Q802, and Q801 go ON because Q805 is OFF. Consequently, current flows to the gates of thyristors D809 and D810, causing these thyristors to be turned ON, and the power amplifier is actuated by high voltage through D805, D806, D807, and D808.
 - When output is effected under the load impedance of less than 7 ohms, current and voltage are detected from both ends of R765 (R766 on the right side) to obtain the load impedance, and the detected output is amplified by IC801.
- When voltage at both ends of C813 rises above 11V, Q805 is turned ON, while Q804, Q803, Q802, and Q801 are turned OFF. As a result, the gate current at D809 and D810 becomes zero, causing these D809 and D810 also to become OFF. This status causes the power amplifier to start functioning at low voltage through D801, D802, D803, and D804.

- Low-voltage functioning is effected at about 70% of high voltage, contributing to improving efficiency during the low-impedance period.

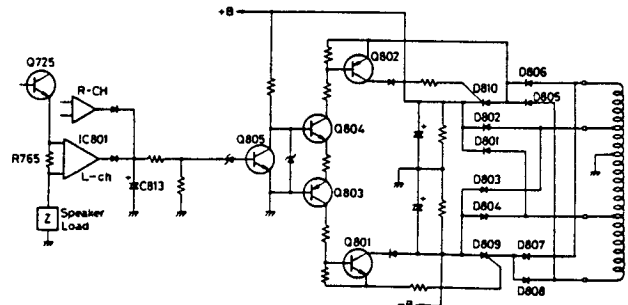

4. Removal Procedures

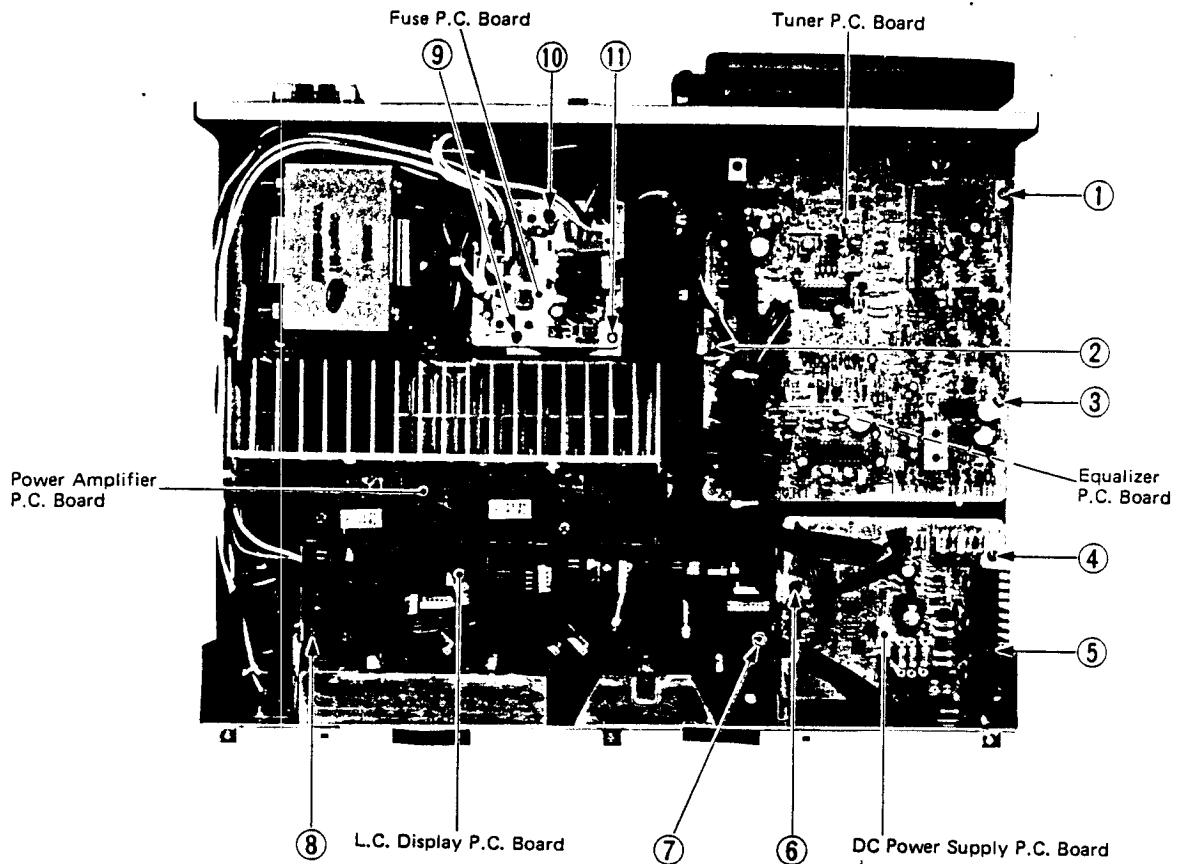

4-(1) Removing the Front Panel

- Step 1: Demount the top cover by removing four screws from the two sides and two screws from the rear.
- Step 2: Remove three screws securing the front panel on its upper side and three screws securing it on the lower side.
- Step 3: Demount the switch PC board secured to the front panel with catches.

4-(2) Removing the Tuner P.C. Board

- Step 1: Demount the top cover (see above item 4-(1), Step 1).
- Step 2: Remove three screws ① through ③ securing the tuner P.C. board on its upper side.
- Step 3: Remove three screws securing the antenna terminal on its rear side.

4-(3) Checking-up the Equalizer P.C. Board

- Step 1: Demount the tuner P.C. board (see above item 4-(2)).
- Step 2: Remove two screws ④, ⑤ and extract the plastic rivet ⑥ securing the DC power supply P.C. board on its upper side.
- Step 3: Demount the bottom cover by removing three screws from the bottom.

4-(4) Removing the L.C. Display P.C. Board

- Step 1: Demount the top cover (see above item 4-(1), Step 1).
- Step 2: Remove two screws ⑦, ⑧ securing the L.C. display P.C. board.

4-(5) Removing the Fuse P.C. Board

- Step 1: Remove the top cover (see above item 4-(1), Step 1).
- Step 2: Remove two plastic rivets ⑨, ⑩ and the screw ⑪ securing the fuse P.C. board.

4-(6) Checking-up the Power Amplifier P.C. Board

- Step 1: Remove the front panel (see above item 4-(1)).
- Step 2: Remove the L.C. display P.C. board (see above item 4-(4)).
- Step 3: Demount the bracket of L.C. display P.C. board by removing four screws from the front bracket.
- Step 4: Demount the bottom cover by removing two screws from the bottom.

5. Adjustment Procedures

5-(1) FM/AM Tuner P.C. Board

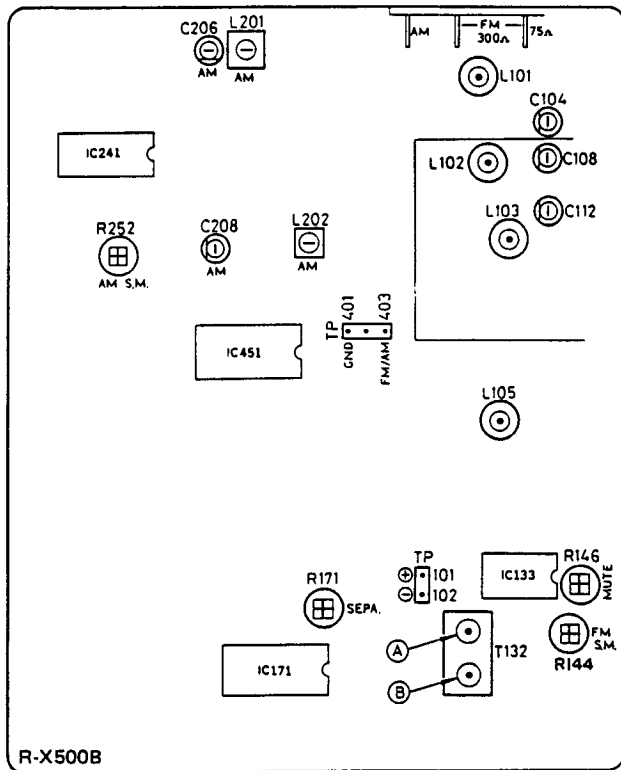

FM Section

Band Cover

1. Set the frequency display to 107.9 MHz.
2. Connect a DC VTVM to TP403 and TP401 (GND).
3. Adjust L105 so that the VTVM shows 9.00 V.
4. And set the frequency display to 87.9 MHz.
5. Check the VTVM voltage reading $1.90\text{ V} \pm 0.5\text{ V}$.

Sensitivity

Low Frequency

1. Connect an RF generator to the antenna terminals on the rear panel through a dummy antenna.
2. Set an RF generator to 90 MHz, a modulation of 1 kHz and a deviation of 75 kHz to provide an input of $2\ \mu\text{V}$.
3. Connect a VTVM and an oscilloscope to the Rec. out jacks on the rear panel.
4. Set the frequency display to 90 MHz.
5. Adjust coils L101, L102 and L103 to maximize the output.

High Frequency

6. Set the RF generator to 106 MHz, a modulation of 1 kHz and a deviation of 75 kHz to provide an input of $2\ \mu\text{V}$.
7. Set the Frequency Display to 106 MHz.
8. Adjust the FM trimmers C104, C108 and C112 to maximize the output.
9. Repeat these high and low frequencies adjustment alternately until maximum sensitivity is obtained.

Discriminator, Distortion and Signal Gain

1. Press to FM position.
2. Connect an RF generator, 1 kHz modulation and a 75 kHz deviation to the antenna terminals on the rear panel through a dummy antenna.
3. Connect an oscilloscope, Distortion Meter and VTVM to the Rec. out jacks on the rear panel.
4. Set the RF generator to 98 MHz, generator output to minimize.
5. Set the Frequency Display to a 98 MHz.
6. Connect a DC VTVM between TP101 and TP102.
7. Adjust the core indicated arrow (A) of T132 for DC VTVM reading of 0 (zero) mV.
8. And set the RF generator output to 1 mV.
9. Adjust the core indicated arrow (B) of T132 so that the distortion is minimized.

Stereo Separation

1. Switch the selector of stereo modulator to left channel modulation.
2. Adjust R171 so that the output of right channel is minimized.
3. Switch the selector of the modulator to right channel modulation.
4. Adjust R171 so that the left channel is minimized.
5. Set R171 to a average, if the separation of left and right is different.

1. Connect the RF generator to the antenna terminal on the rear panel.
2. Set the RF generator at 100.1 MHz, $5\ \mu\text{V}$. Rotate R146 clockwise, and stop rotating at the point where muting is eliminated (signals are output).
3. Set the RF generator at 100.1 MHz, $100\ \mu\text{V}$. While rotating R144 clockwise, adjust the FM-signal strength meter so that this meter displays 40 dB.

For Service Manuals Contact
MAURITRON TECHNICAL SERVICES
 8 Cherry Tree Rd, Chinnor
 Oxon OX9 4QY
 Tel:- 01844-351694 Fax:- 01844-352554
 Email:- enquiries@mauritron.co.uk

AM Section

Band Cover

1. Press to AM position.
2. Set the frequency display to 530 kHz (10 kHz channel step), or 522 kHz (9 kHz channel step).
3. Connect DC VTVM to TP403 and TP401 (GND).
4. Adjust L202 so that the VTVM shows 1.05 V (530 kHz), or 0.95 V (522 kHz).
5. And set the frequency display to 1710 kHz (10 kHz channel step), or 1611 kHz (9 kHz channel step).
6. Adjust C208 so that the DC VTVM reads 9.00 V for 1710 kHz, or 7.50 V for 1611 kHz.

Tracking and Sensitivity

1. Connect the loop antenna. Also connect the RF generator to the antenna terminal on the rear panel.
2. Set the generator to 600 kHz (or 603 kHz) with 30 % modulation at 400 Hz.

3. Set the frequency display to 600 kHz, or 603 kHz.
4. Adjust L201 to maximize the output.
5. Set the generator to 1400 kHz, or 1404 kHz.
6. Set the frequency display of the unit to 1400 kHz or 1404 kHz.
7. Adjust C206 so that the output signal is maximized.
8. Repeat these adjustments (1 ~ 7) alternately until maximum sensitivity is obtained.

AM-signal Strength Meter

1. Connect the RF generator to the antenna terminal on the rear panel. On this work, use the dummy antenna and achieve connection in series via 5.6 k Ω .
2. Set the RF generator either at 999 kHz (9 kHz step) or 1,000 kHz (10 kHz step), 10 mV.
3. While rotating R252 clockwise, adjust the AM-signal strength meter so that this meter displays 90 dB.

5-(2) Power Amplifier P.C. Board

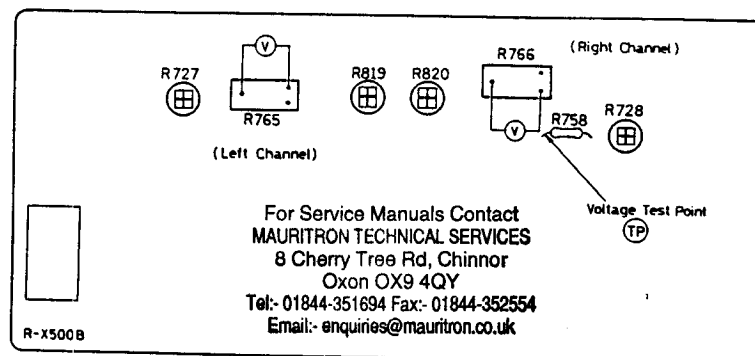

Idling Current Adjustment

1. Turn R727 and R728 fully counterclockwise before the power switch on.
2. Allow the set warm up at least 5 minutes before adjustment.
3. Must keep the heatsink to prevent overheating before adjustment.

4. Set the volume control to minimum during this adjustment.
5. Connect a DC VTVM to R765 resistor's leads for left channel, or to R766's leads for right channel.
6. Adjust R727 for left channel, or R728 for right channel, so that the DC VTVM reads 5 mV.

Power supply switching circuit adjustment

1. Before turning the power ON, turn the semi-fixed resistors (R819 for Left channel and R820 for Right channel) of the amplifier circuit board fully counterclockwise.
2. Turn the power ON and input a 20 Hz sine wave to the Left channel (or the Right channel) of the AUX. Then, connect a 7 Ω dummy load to the speaker terminal, adjust either the amplifier's volume or the oscillator's volume to obtain 29 V output.
3. Measure voltage on the R758 (TP) and confirm that the range of "50 V \pm 3 V" exists. Next, slowly rotate clockwise the semi-fixed resistors (R819/L or R820/R) and set voltage at the R758 (TP) to the level of 38 V \pm 3 V.
4. Shift the dummy load from 7 ohms to 8 ohms and confirm that voltage at the R758 (TP) is 50 V

\pm 3 V. When this voltage is out of the range (50 V \pm 3 V), readjust the semi-fixed resistors.

- Note:**
- Adjust on one channel at a time, either on the "L" channel or the "R" channel.
 - When you need dummy (7 ohms/8 ohms), consult with JVC.
 - When speaker output is observed with an oscilloscope, waveforms present a "clip" status after voltage has been switched (after TP has become 38 V \pm 3 V).

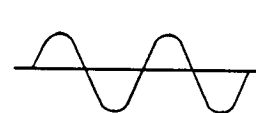

Under Steps 2 and 4

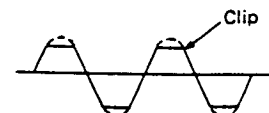

Under Step 3

R-X500B Schematic Diagram

7-(1) R-X500B Tuner Section

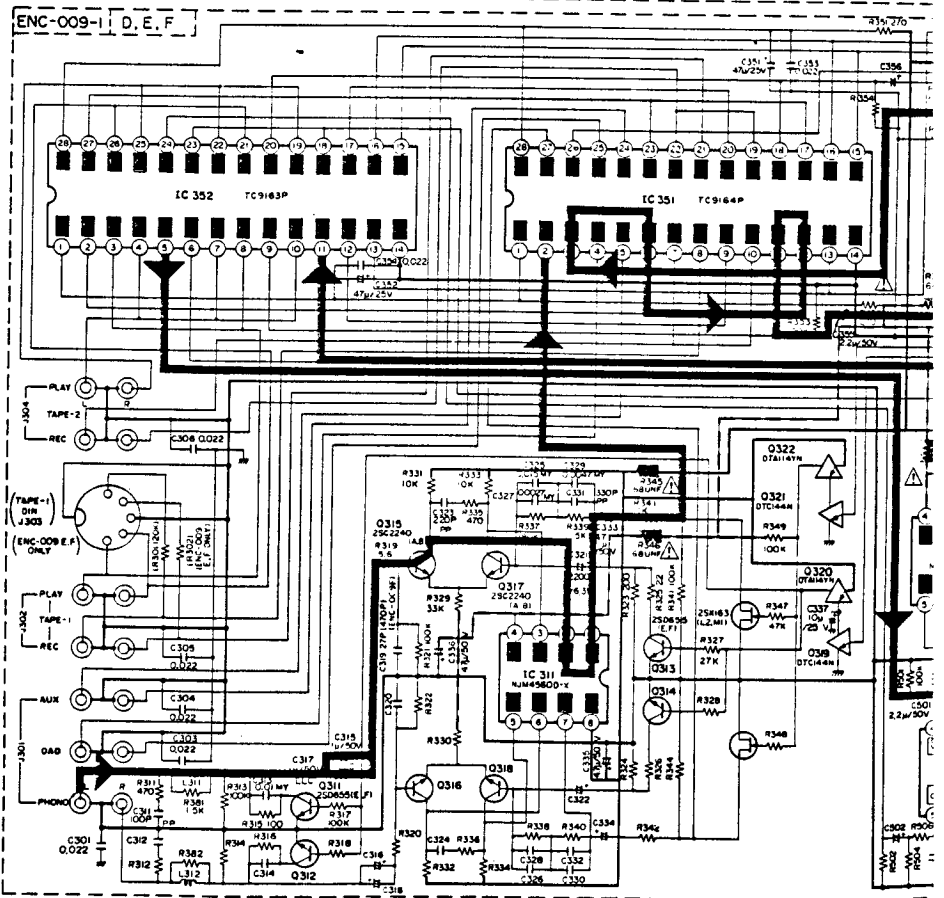
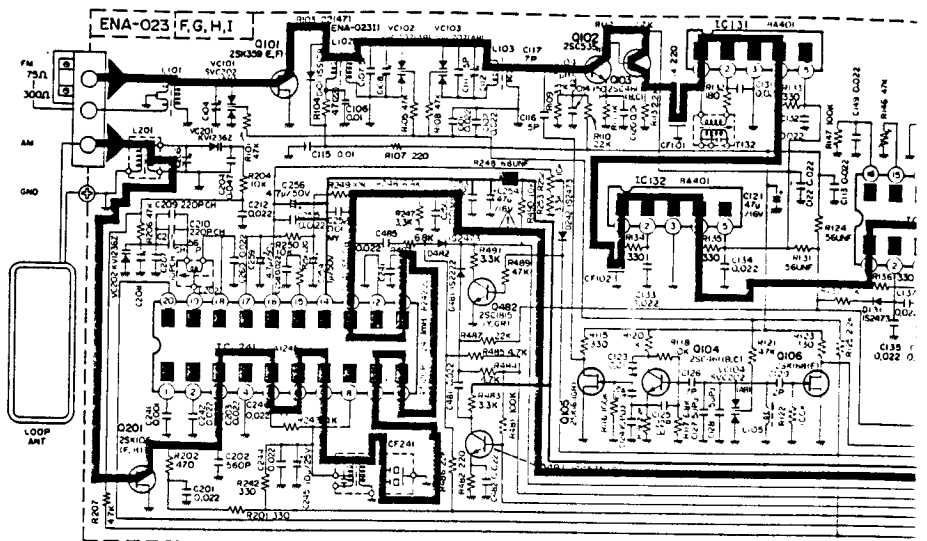

For Service Manuals Contact
MAURITRON TECHNICAL SERVICES
 8 Cherry Tree Rd, Chinnor
 Oxon OX9 4QY
 Tel:- 01844-351694 Fax:- 01844-352554
 Email:- enquiries@mauritron.co.uk

Notes:

1. ██████ shows DC voltage to the chassis with no signal input.
2. indicates positive B power supply.
3. indicates negative B power supply.
4. indicates signal path.
5. When replacing the parts in the darkened are those marked with △, be sure to use the dc to ensure safety.
6. This is the standard circuit diagram. The design and contents are subject to cl notice.

00B Schematic Diagram

00B Tuner Section

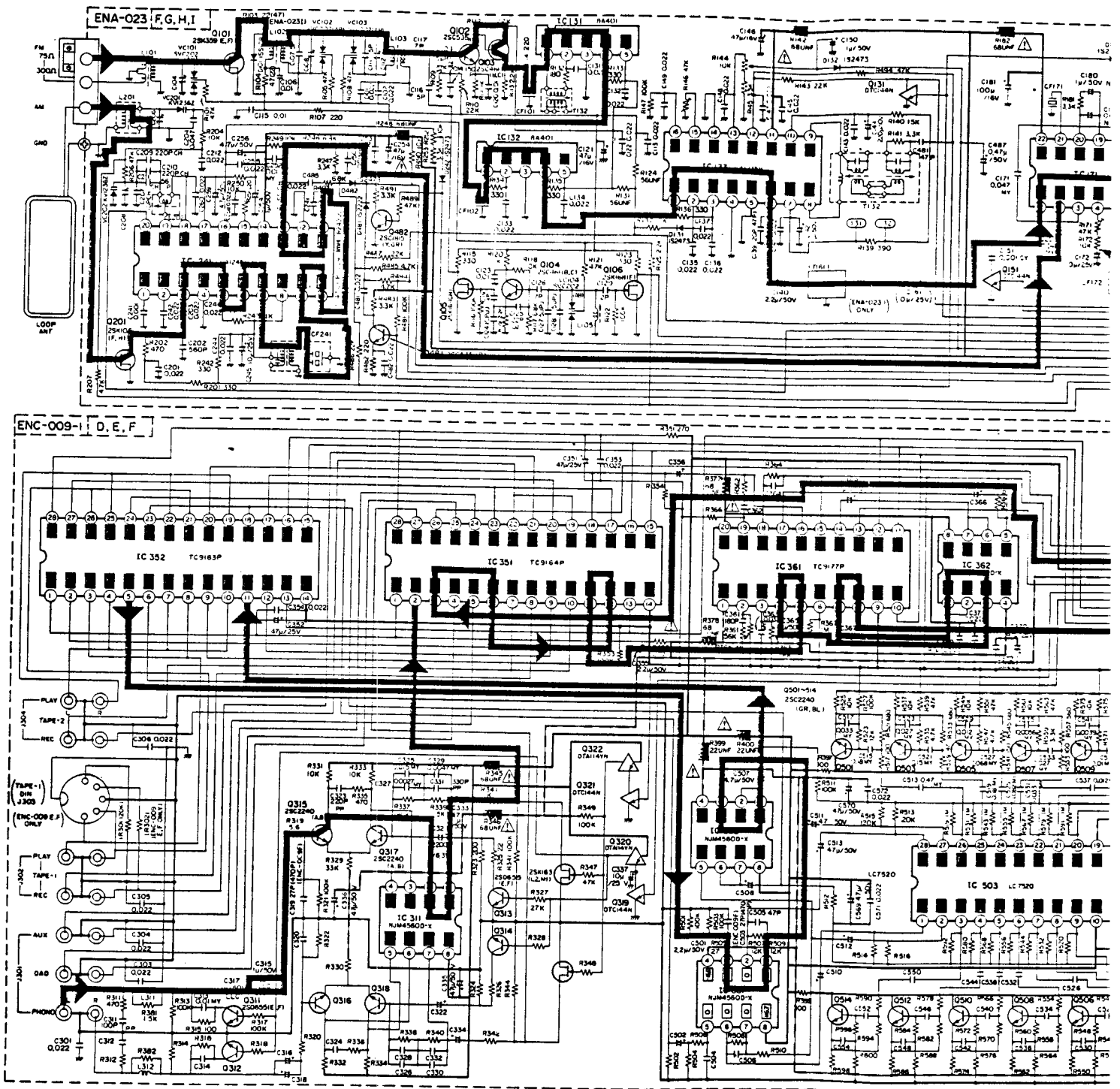

DC voltage to the chassis with no signal input.
 es positive B power supply.
 es negative B power supply.
 es signal path.

5. When replacing the parts in the darkened area (████████) and those marked with Δ , be sure to use the designated parts to ensure safety.
6. This is the standard circuit diagram.
 The design and contents are subject to change without notice.

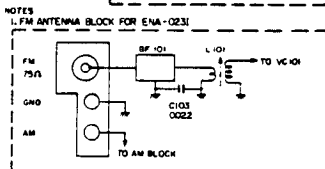
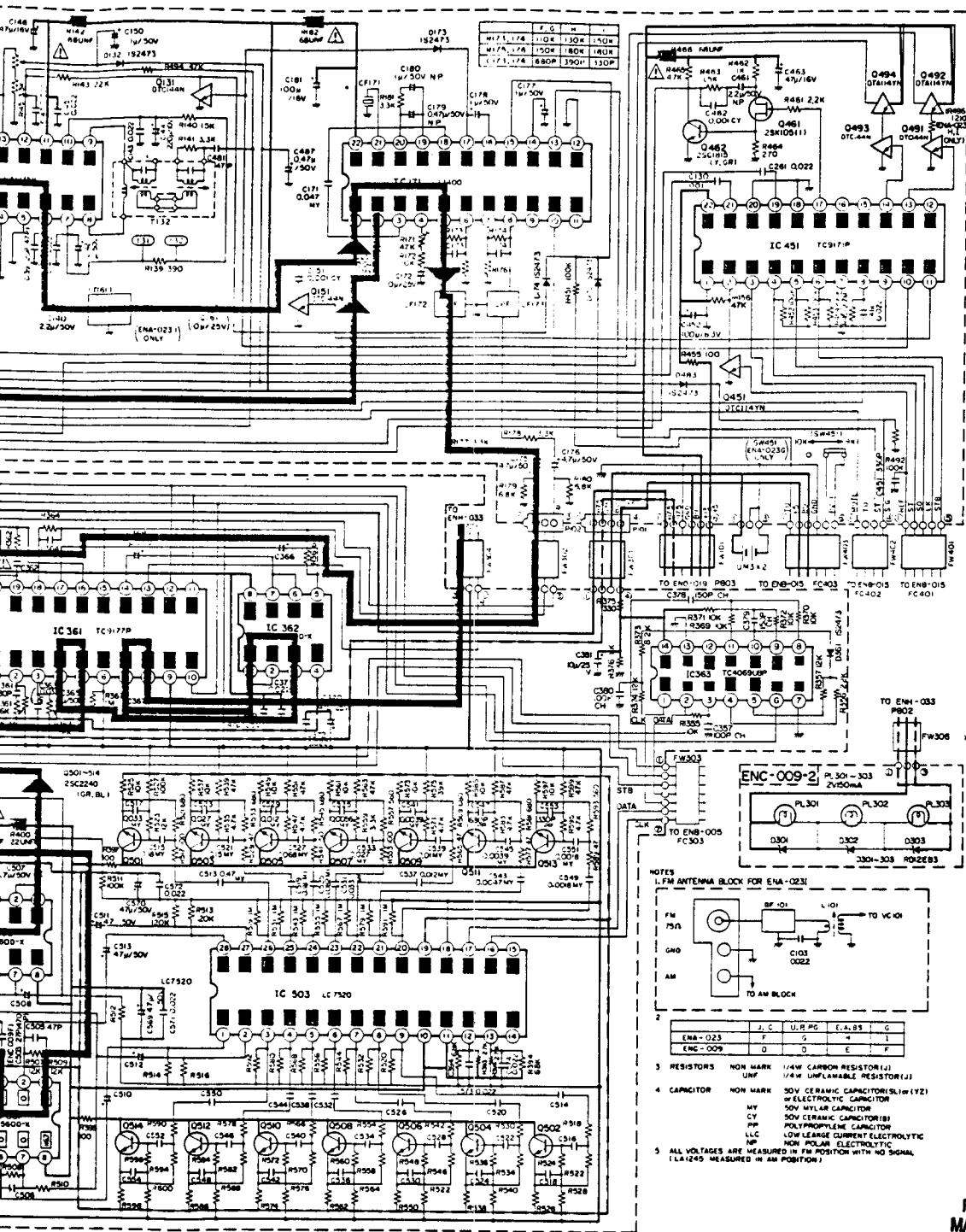

	J	C	U, R, PG	E, A, BS	G
ENA-023	F	G	4	1	
ENC-009	G	D	E	F	

3. RESISTORS NON MARK 1/4W CARBON RESISTOR(I)
UNF 1/4W UNFLAMMABLE RESISTOR(I)

4. CAPACITOR NON MARK 50V CERAMIC CAPACITOR(S)W(LVZ)
W ELECTROLYTIC CAPACITOR
MY 50V MYLAR CAPACITOR
CV 50V CERAMIC CAPACITOR(I)
PP POLYPROPYLENE CAPACITOR
LLC LOW LEAKAGE CURRENT ELECTROLYTIC
NP NON POLAR ELECTROLYTIC
5. ALL VOLTAGES ARE MEASURED IN FM POSITION WITH NO SIGNAL
(LA1245 MEASURED IN AM POSITION)

() and
gnated parts
ge without



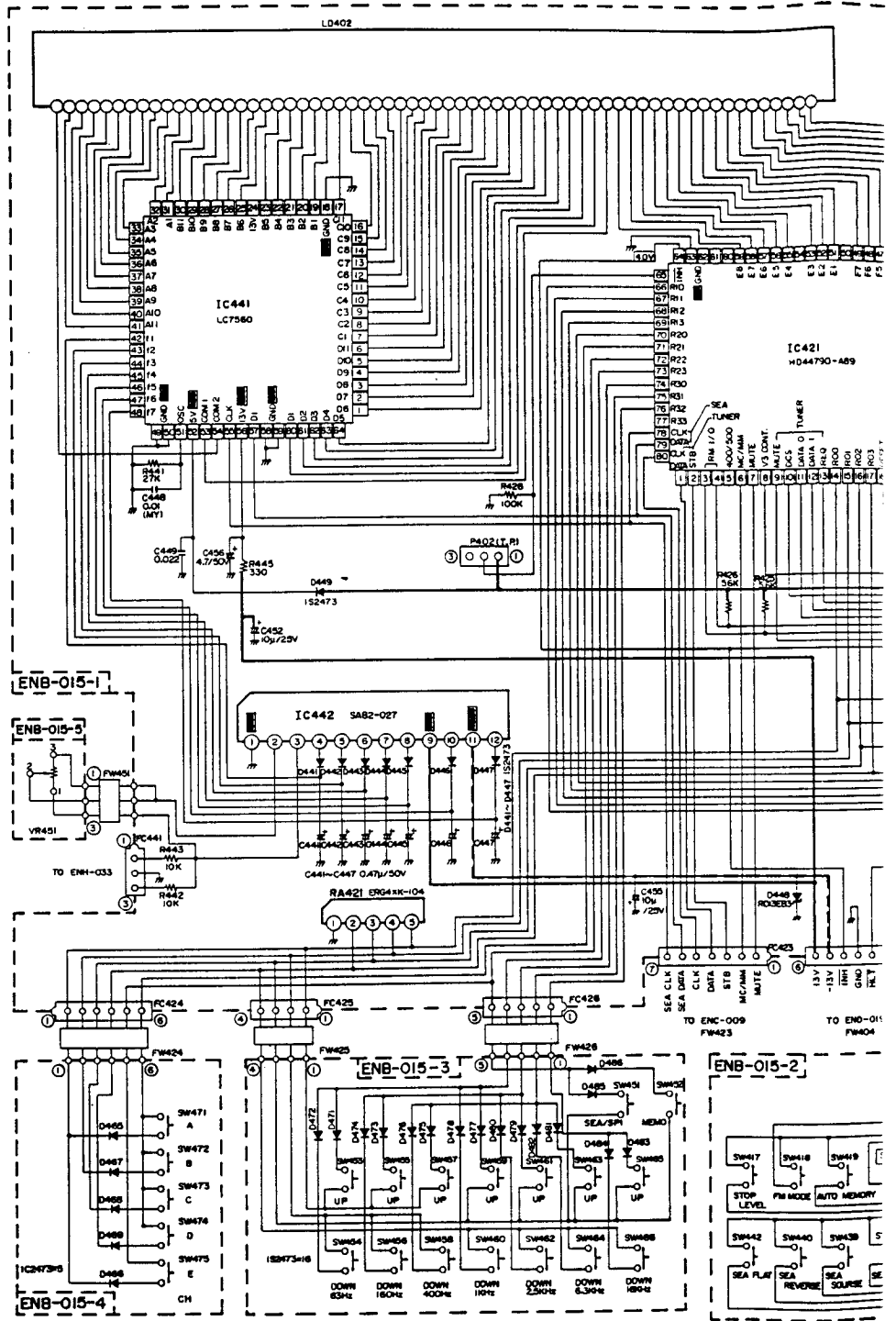

For Service Manuals Contact
MAURITRON TECHNICAL SERVICES
 8 Cherry Tree Rd, Chinnor
 Oxon OX9 4QY
 Tel:- 01844-351694 Fax:- 01844-352554
 Email:- enquiries@mauritron.co.uk

7-(2) R-X500B Logic Section



For Service Manuals Contact
 MAURITRON TECHNICAL SERVICES
 8 Cherry Tree Rd, Chinnor
 Oxon OX9 4QY
 Tel:- 01844-351694 Fax:- 01844-352554
 Email:- enquiries@mauritron.co.uk

Notes:

1.  shows DC voltage to the chassis with no signal input.
2.  indicates positive B power supply.
3.  indicates negative B power supply.
4.  indicates signal path.

5. When replacing the parts in the darkened area () those marked with Δ , be sure to use the designated p to ensure safety.
6. This is the standard circuit diagram.
The design and contents are subject to change with notice.

R-X500B

R-X500B

tion

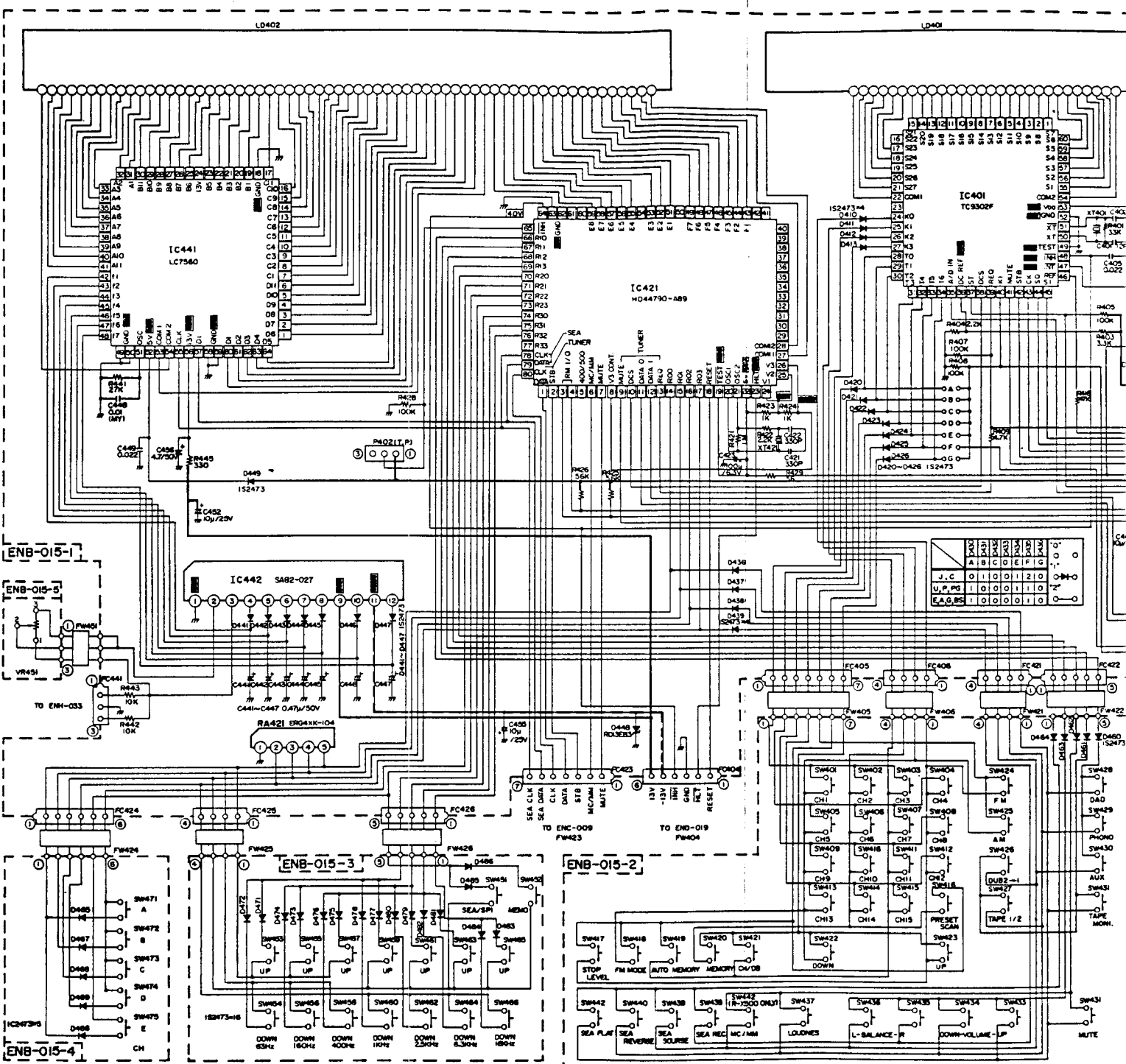

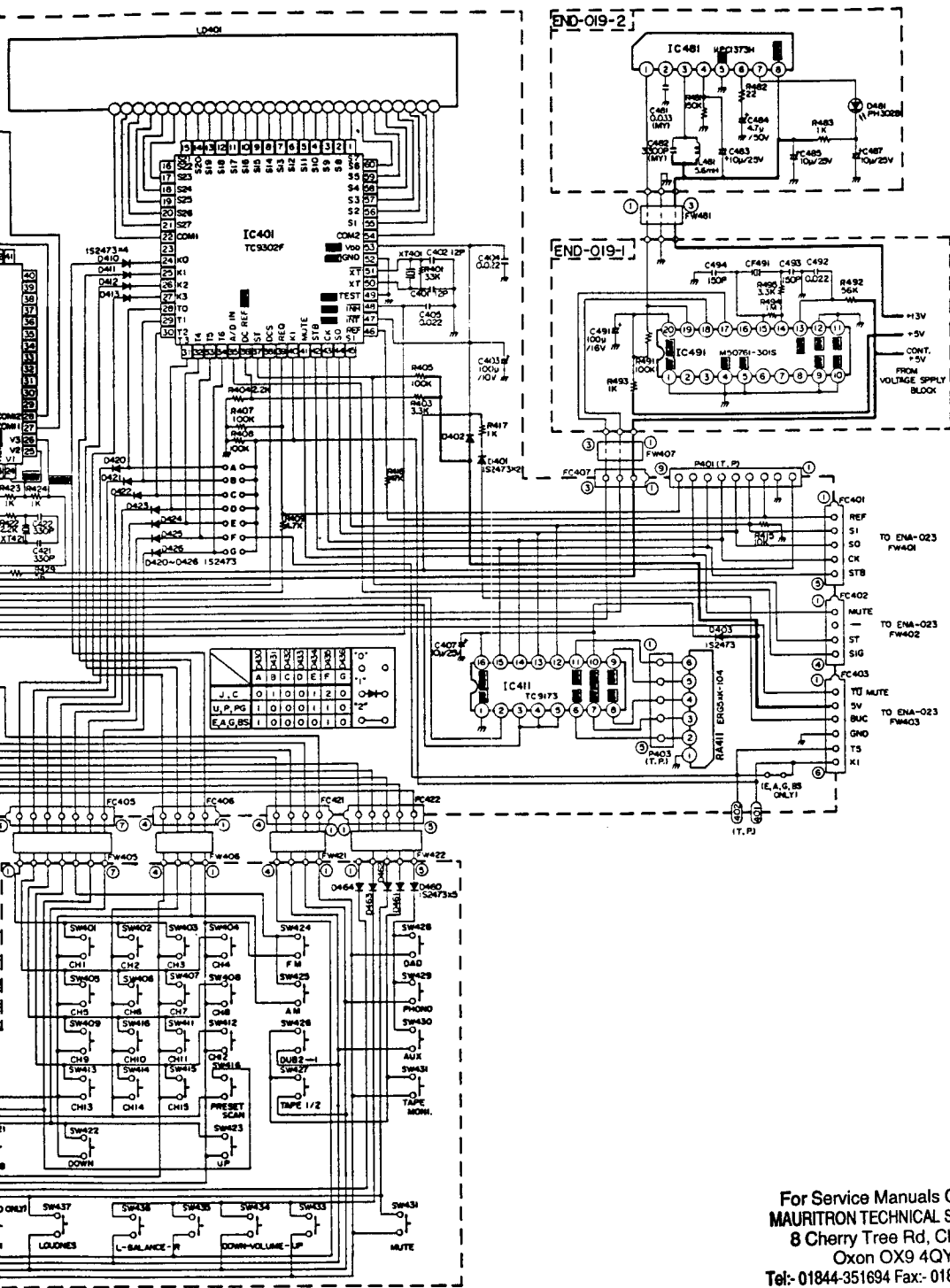

For Service Manuals Contact
MAURITRON TECHNICAL SERVICES
 8 Cherry Tree Rd, Chinnor
 Oxon OX9 4QY
 Tel:- 01844-351694 Fax:- 01844-352554
 Email:- enquiries@mauritron.co.uk

7-(3) R-X500B Amplifier Section

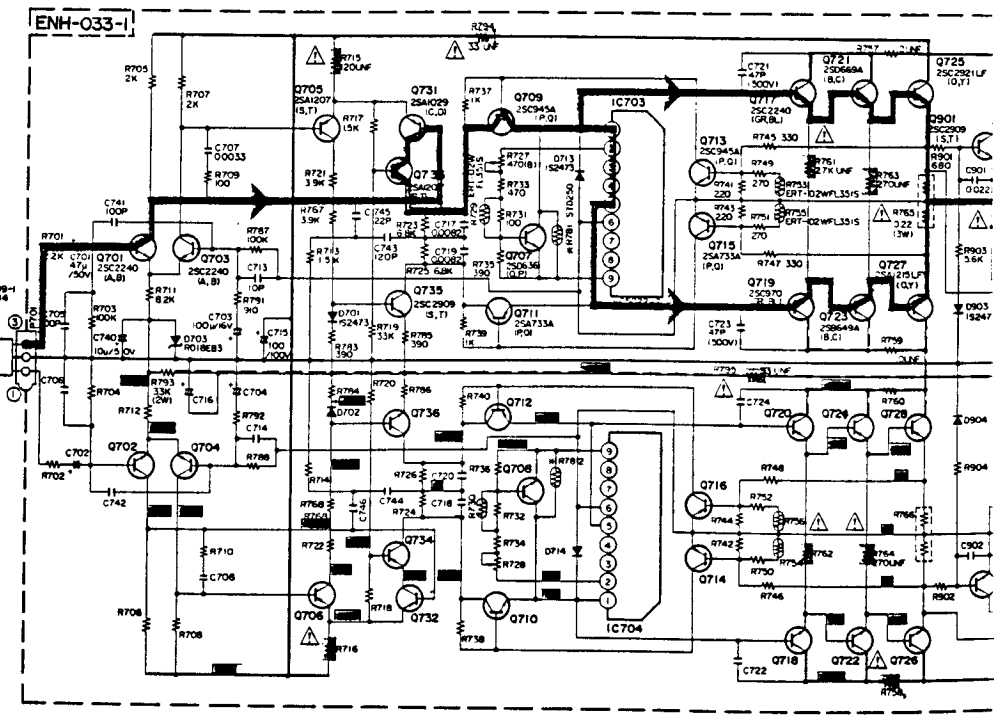
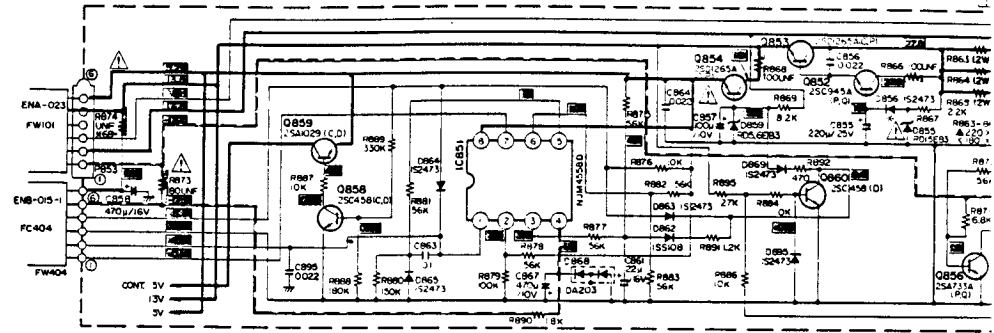
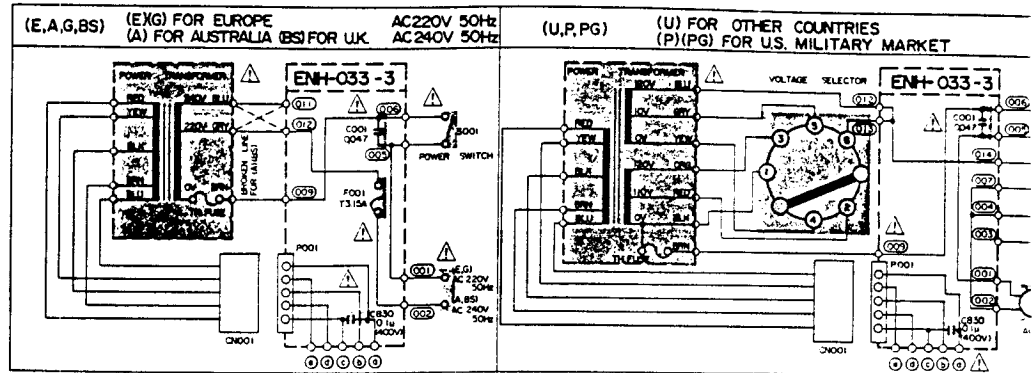

For Service Manuals Contact
MAURITRON TECHNICAL SERVICES
 8 Cherry Tree Rd, Chinnor
 Oxon OX9 4QY
 Tel: 01844-351694 Fax: 01844-352554
 Email: enquiries@maurtron.co.uk

Notes:

1. shows DC voltage to the chassis with no signal input.
2. indicates positive B power supply.
3. indicates negative B power supply.
4. indicates signal path.
5. When replacing the parts in the darkened area (those marked with Δ), be sure to use the design to ensure safety.
6. This is the standard circuit diagram. The design and contents are subject to change notice.

Section

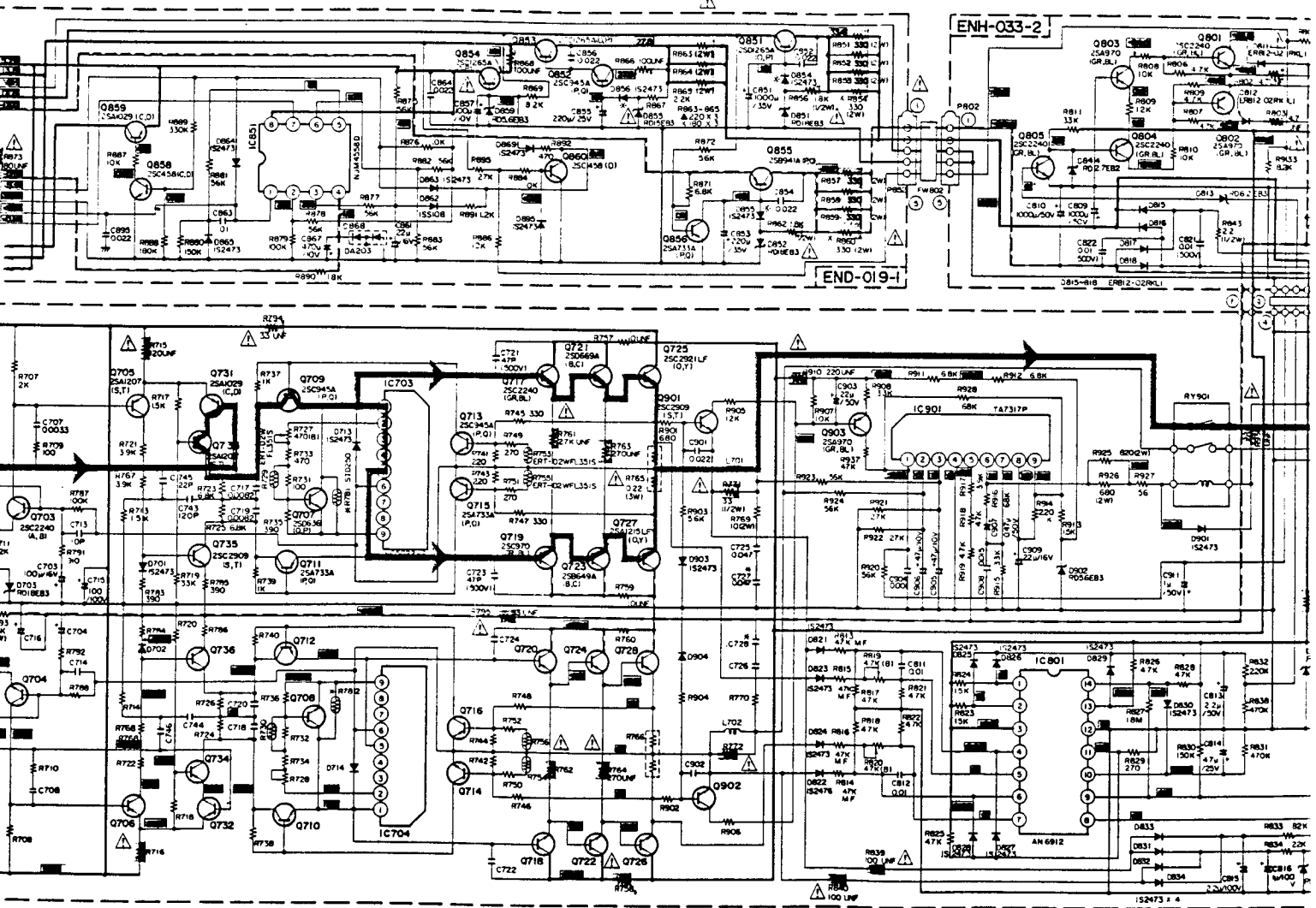
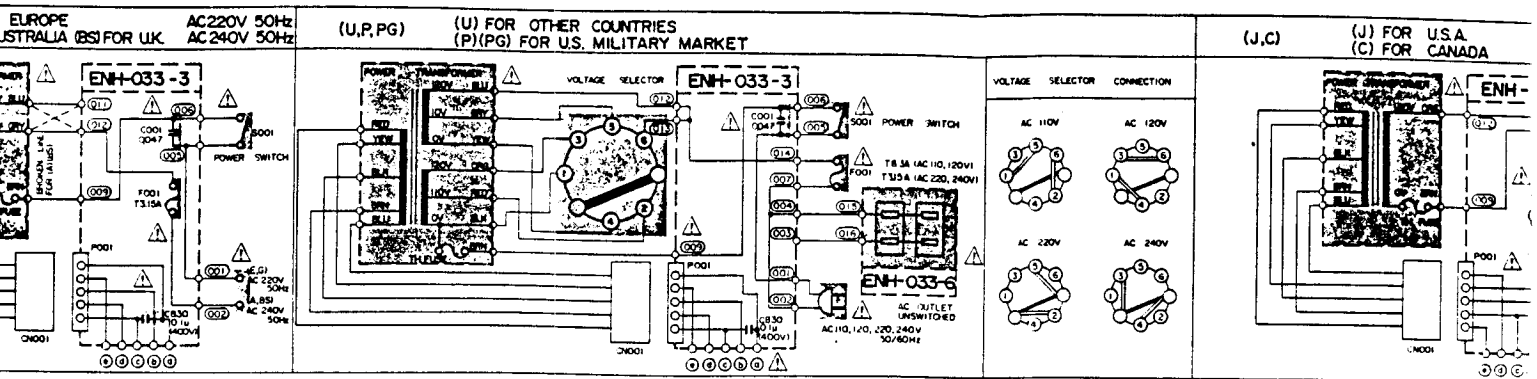

- When replacing the parts in the darkened area () and those marked with Δ , be sure to use the designated parts to ensure safety.
- This is the standard circuit diagram. The design and contents are subject to change without notice.

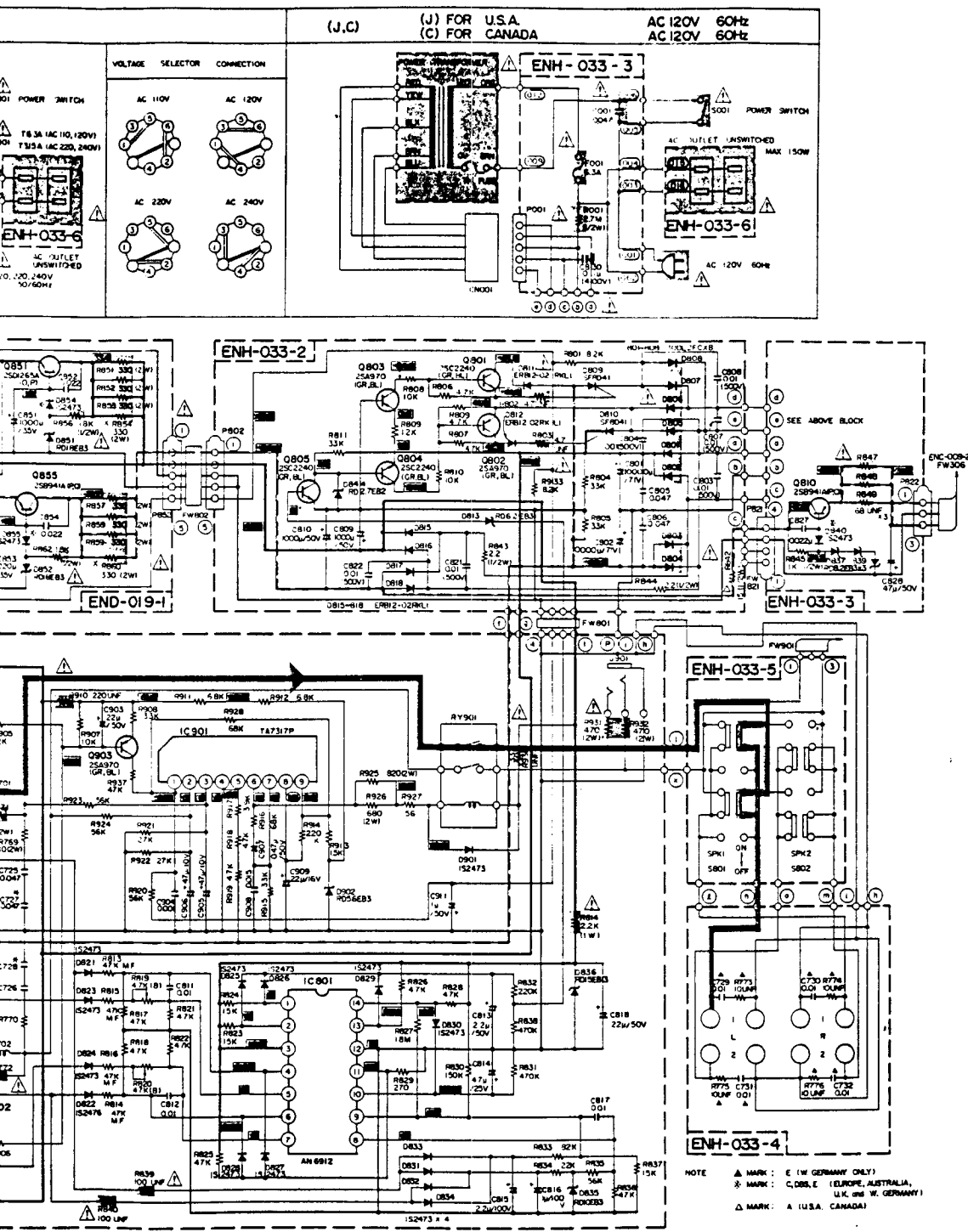

and
ated parts
e without

For Service Manuals Contact
MAURITRON TECHNICAL SERVICES
 8 Cherry Tree Rd, Chinnor
 Oxon OX9 4QY
 Tel: 01844-351694 Fax: 01844-352554
 Email: enquiries@mauritron.co.uk

8. Servicing Method for AWG #20 Wires with Clamping Terminals

(1) Application objective → Confirmation of safety
Used to prevent breakage/disconnection troubles of primary and secondary wires within PC boards (or between PC boards). Even when wire breakage/disconnection has actually occurred, a safe air-gap distance between the primary wire and the secondary wire/possibly contacting metal surface can be maintained because the terminal retains the wire sheathing.

(2) Type of wire used

- ① 1015 AWG-#20 (single-coated)
- ② 1672 AWG-#20 (double-coated)

(3) Servicing precautions

- ① The structural design of this terminal causes its catch to hook onto the PC board, preventing the wire from being easily pulled out. As shown in the figure, use cutting pliers or a similar tool to cut off the ends of the terminal and wire; then remove the remaining terminal clip by melting the soldering.

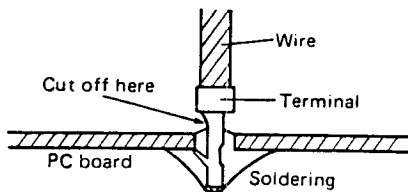

- ② Prior to soldering the wire onto the PC board, confirm safety by pressure-fitting the terminal to the wire by observing the following procedures.

1. Strip off the wire 5 ~ 6 mm from its end.

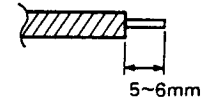

2. Insert the wire until its sheathing contacts section "A" of the terminal and pressure-fit the terminal clamp at three sections of (a), (b), and (c) (section (c) is especially important to assure safety. Exercise particular care to achieve secure clamping).

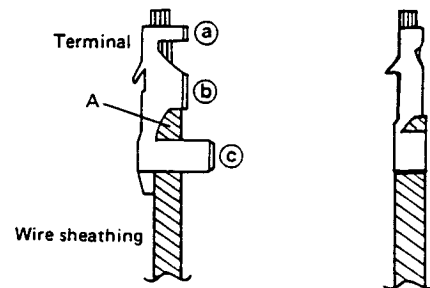

③ Part No., and name

Part No. : 5298T
Name : CRIMP PIN

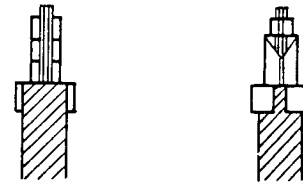

For Service Manuals Contact
MAURITRON TECHNICAL SERVICES
8 Cherry Tree Rd, Chinnor
Oxon OX9 4QY
Tel:- 01844-351694 Fax:- 01844-352554
Email:- enquiries@mauritron.co.uk

9. Handling precautions of LCD panels

The LCD (Liquid Crystal Display) panel employed in this device requires the following handling precautions.

1. Since the LCD is made of plate glass, never apply strong mechanical impact to it.

Do not forcibly press the light-polarizing plate.

When handling, grip it as shown in the figure below.

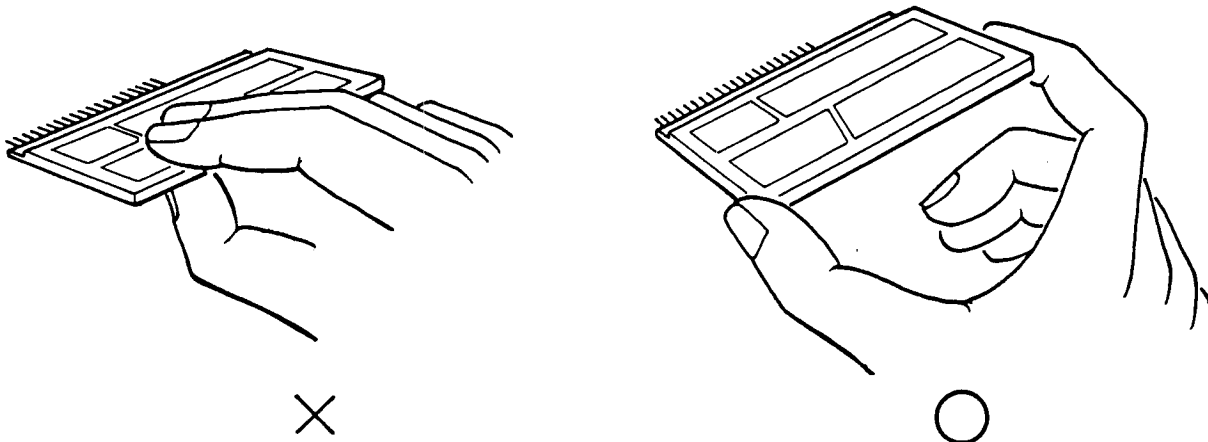

2. When handling the LCD, wear gloves whenever possible.
3. When the light-polarizing plate (surface other than silk-printed areas) becomes contaminated, use an applicator wet with isopropyl alcohol to gently wipe it clean. As for the silk-printed areas, use a soft cloth also to gently wipe it clean.
NOTE: The light-polarizing plate attached to the LCE surface and the silk-printed areas are made of soft material.
4. As much as possible, avoid exposing the LCD to irradiation of harmful light (direct sunlight or ultraviolet rays), especially when the device is not in use.
5. Do not imprint DC voltage on pins of the LCD (characteristics will be degraded).
6. When the LCD is damaged, resulting in leakage of liquid crystal, be very cautious to avoid the liquid from penetrating one's mouth or being swallowed. Should liquid crystal contact the hands or clothing, immediately wash with water, using soap or other appropriate cleanser.

For Service Manuals Contact
MAURITRON TECHNICAL SERVICES
 8 Cherry Tree Rd, Chinnor
 Oxon OX9 4QY
 Tel:- 01844-351694 Fax:- 01844-352554
 Email:- enquiries@mauritron.co.uk

JVC

VICTOR COMPANY OF JAPAN, LIMITED
 STEREO DIVISION, YAMATO PLANT, 1644, SHIMOTSURUMA, YAMATO-SHI, KANAGAWA-KEN, 242, JAPAN

PARTS LIST

For Service Manuals Contact
MAURITRON TECHNICAL SERVICES
8 Cherry Tree Rd, Chinnor
Oxon OX9 4QY
Tel: 01844-351694 Fax: 01844-352554
Email: enquiries@mauritron.co.uk

Contents

1. Main Parts Locations	2-2
2. Exploded View and Part Numbers	2-3
3. Printed Circuit Board Ass'y and Parts List	2-6
3-(1) END-019 <input type="checkbox"/> DC Power Supply P.C. Board Ass'y	2-6
3-(2) ENH-033 <input type="checkbox"/> Audio P.C. Board Ass'y	2-8
3-(3) ENB-015 <input type="checkbox"/> L.C. Display P.C. Board Ass'y	2-12
3-(4) ENA-023 <input type="checkbox"/> Tuner P.C. Board Ass'y	2-15
3-(5) ENC-009 <input type="checkbox"/> Amp P.C. Board Ass'y	2-19
4. Packing Materials and Part Numbers	2-23
5. Accessories List	2-23

1. Main Parts Locations

1-(1) Front View

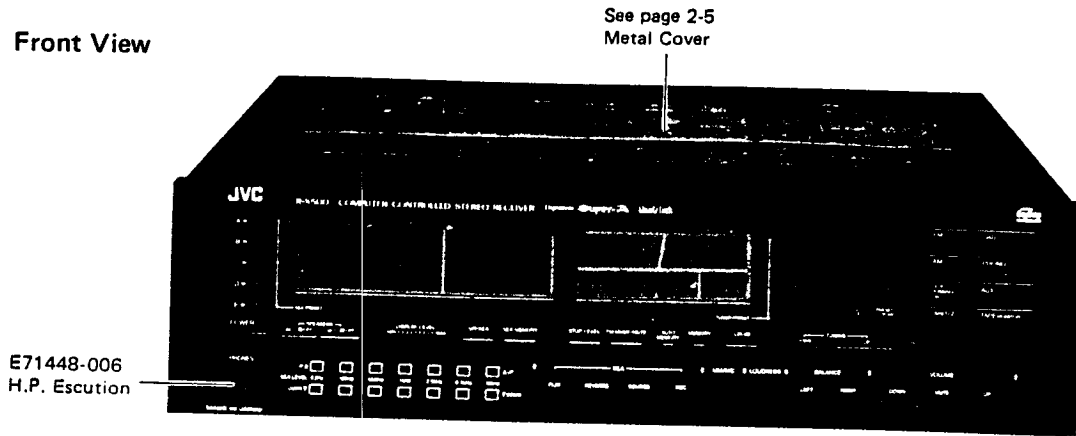

1-(2) Top View

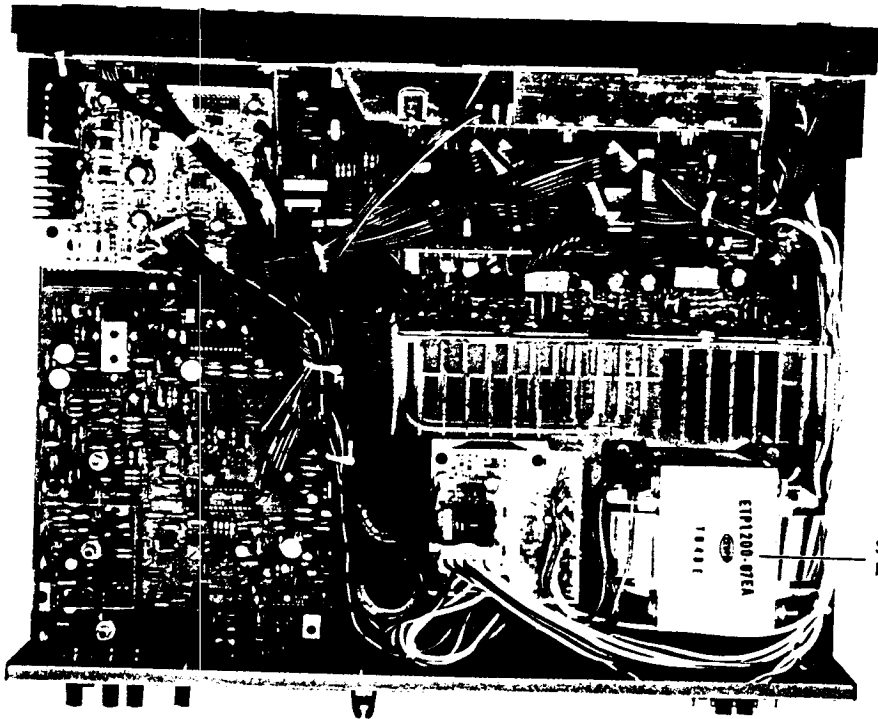

See page 2-5 Power Trnsformer Δ

Δ : Safety Parts

For Service Manuals Contact
MAURITRON TECHNICAL SERVICES
 8 Cherry Tree Rd, Chinnor
 Oxon OX9 4QY
 Tel:- 01844-351694 Fax:- 01844-352554
 Email:- enquiries@maurtron.co.uk

1-(3) Rear View

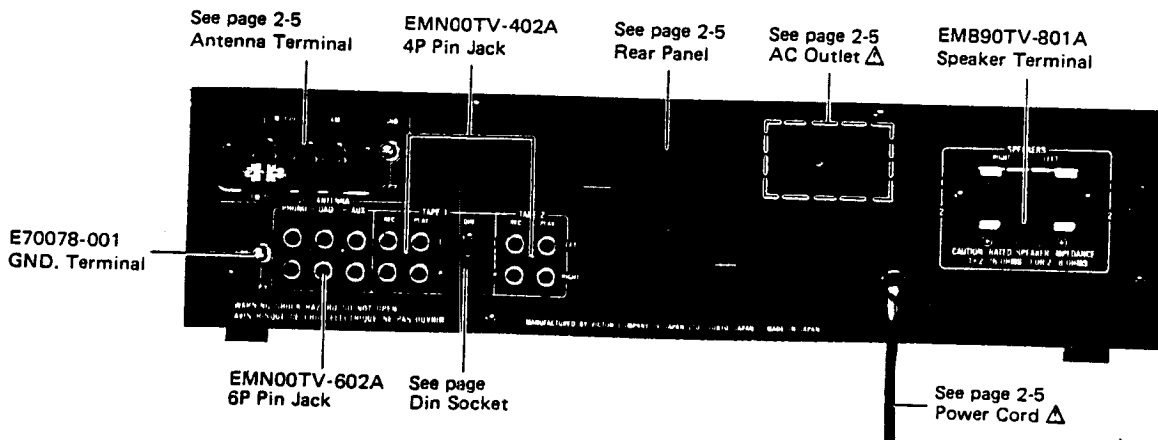

Δ : Safety Parts

2. Exploded View and Part Numbers

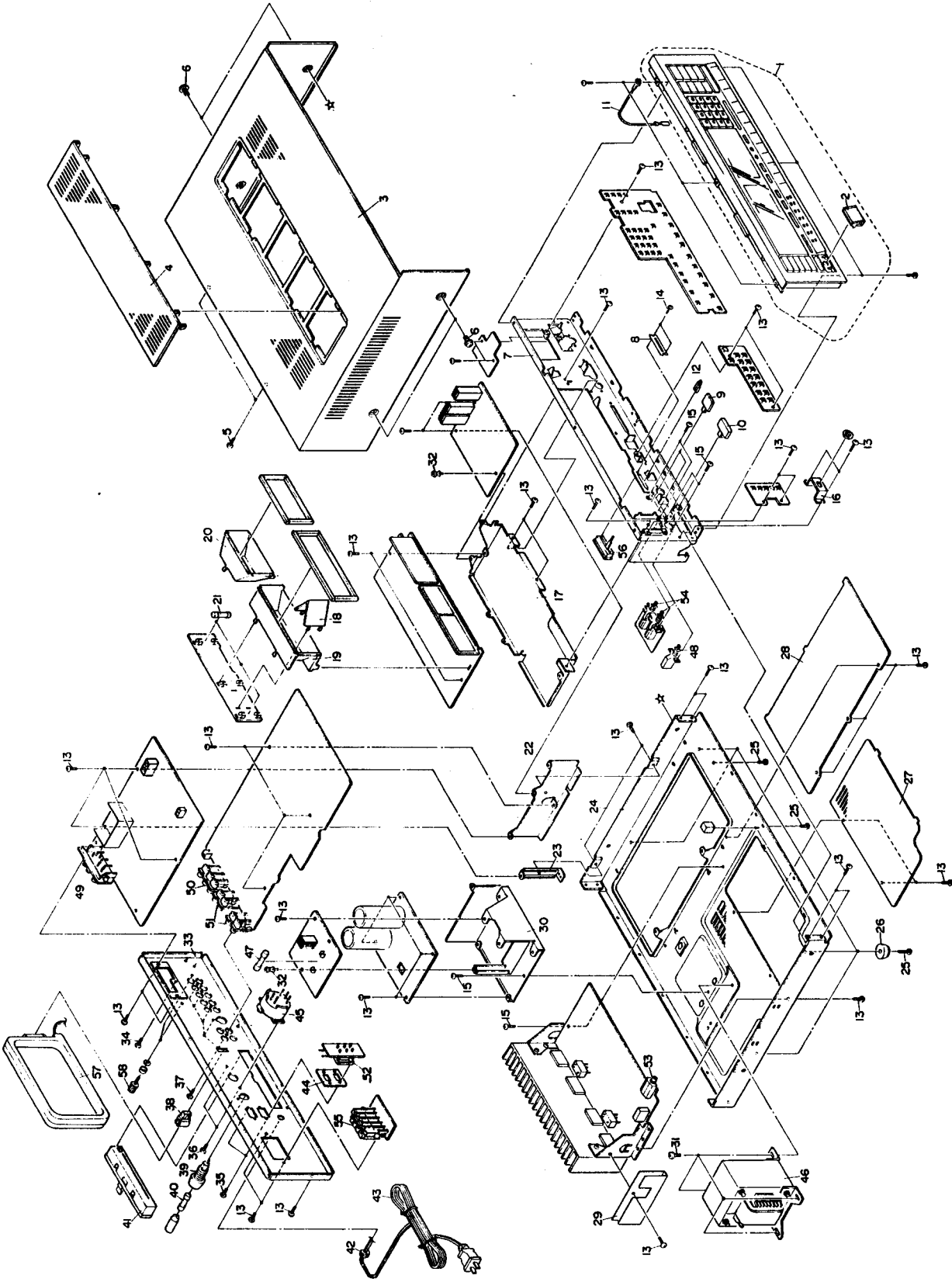

(No. 2733) 2-3

2-4 (No. 2733)

No.	Part Number	Part Name	Q'ty	Description	Area
1	EFP-RX500BE	Front Panel Ass'y	1		
2	E71448-006	H.P. Escution Ass'y	1		
3	E24760-002	Metal Cover	1		J, C, U, P, PG, A, G
	E24761-002	Metal Cover	1		E, BS
4	E23862-004	Grill	1		E, BS
5	SBSB3008N	Screw	2		
6	E61660-004	Screw	4		
7	E24692-005	Front Bracket	1		
8	E71254-001	Felt Soacer	1		
9	E71268-002	Push Knob	2		
10	E71267-002	Push Knob	1		
11	E71240-003	Wire Ass'y	1		
12	E69406-004	Blance Knob	1		
13	SBSB3008N	Screw	47		
14	E70053-001	Screw	2		
15	E65119-001	Screw	6		
16	E71285-002	H.P. Bracket	1		
17	E303400-001	LCD Bracket	1		
18	E71428-001	Reflector	1		
19	E303393-001	Lamp Holder	1		
20	E303283-001	Lamp Holder	1		
21	ELP4101-003	Lamp	3		
22	E303395-001	C.B. Holder	1		
23	E71278-002	C.B. Holder	1		
24	E10745-003	Chassis Base	1		
25	SBSB3010N	Screw	6		
26	E47227-012	Foot	4		
27	E302295-001	Bottom Cover	1		
28	E302294-001	Bottom Cover	1		
29	E69500-003	Sheet	1		
30	E303394-001	C.B. Holder	1		
31	E65389-002	Ass'y Screw	4		
32	E48729-008	Plastic Rivet	2		
33	E24758-009	Rear Panel	1		J, C
	E24758-010	Rear Panel	1		U, P, PG
	E24758-011	Rear Panel	1		E, A, BS
	E24758-012	Rear Panel	1		G
34	SBSB3008N	Screw	1		G
35	SDSB3008N	Screw	2		J, C, U, P, PG
36	SBSB3008N	Screw	2		U, P, PG
37	SBSB3008N	Screw	4		E, A, G, BS
38	E302334-001	Antenna Holder	1		
39	QMG0301-003	Fuse Holder	1		U, P, PG
40	QMF51A2-6R3	Fuse	1		U, P, PG
	QMF51A2-3R15S	Fuse	1		P, PG
41	E303323-001	Battery Case	1		
42	QHS3876-162	Cord Stopper	1		J, C, U, P, PG, E, A, G
	QHS3876-162BS	Cord Stopper	1		BS
△ 43	QMP1200-200	Power Cord	1		J
	QMP1900-200	Power Cord	1		C
	QMP7600-200	Power Cord	1		U, P, PG
	QMP3900-200	Power Cord	1		E, G
	QMP2560-244	Power Cord	1		A
	QMP9170-008BS	Power Cord	1		BS
44	E69589-002	Spacer	1		J
△ 45	QSR0085-00BU	Voltage Selector	1		U, P, PG
△ 46	ETP1200-07JA	Power Transformer	1		J, C
	ETP1200-07FA	Power Transformer	1		U, P, PG
	ETP1200-07EA	Power Transformer	1		E, G, A
	ETP1200-07EABS	Power Transformer	1		BS
△ 47	QMF61U1-6R3	Fuse	1		J, C
	QMF51A2-3R15S	Fuse	1		E, G, A
	QMF51A2-3R15SBS	Fuse	1		BS
48	QSP1106-005	Power Transformer	1		J, C, U, P, PG, E, A, G
	QSP1106-005BS	Power Transformer	1		BS
49	E03572-016	Antenna Terminal	1		J, C, U, P, PG, E, A, BS
50	EMB01YV-201A	Antenna Terminal	1		G
51	EMN00TV-602A	6P Pin Jack	1		
51	EMN00TV-402A	4P Pin Jack	2		
△ 52	QMC0437-002	AC Outlet	1		J, C, U, P, PG
53	QMS6302-125	H.P. Jack	1		
54	QST4261-E07	Speaker Switch	2		
55	EMB90TV-801A	Speaker Terminal	1		
56	QVZ5310-001	Variable	1		
57	EQB4001-008	Bar Antenna Coil	1		
58	E70078-001	GND. Terminal	1		

The Marks for Designated Areas.

- J U.S.A.
- C Canada
- E Continental Europe
- G West Germany
- A Australia
- P, PG U.S. Military Market
- BS U.K.
- U Other Countries

For Service Manuals Contact
MAURITRON TECHNICAL SERVICES
 8 Cherry Tree Rd, Chinnor
 Oxon OX9 4QY
 Tel:- 01844-351694 Fax:- 01844-352554
 Email:- enquiries@mauritron.co.uk

△ : Safety Parts

3. Printed Circuit Board Ass'y and Parts List

3-(1) END-019 □ DC Power Supply P.C. Board Ass'y

Note: END-019 □ varies according to the areas employed. See note(1) when placing on order.

Note (1)

P.C. Board Ass'y	Designated Areas
END-019 □ C	U.S.A., Canada, U.S. Military Market & Other Countries
END-019 □ D	Europe, Australia, U.K. & West Germany

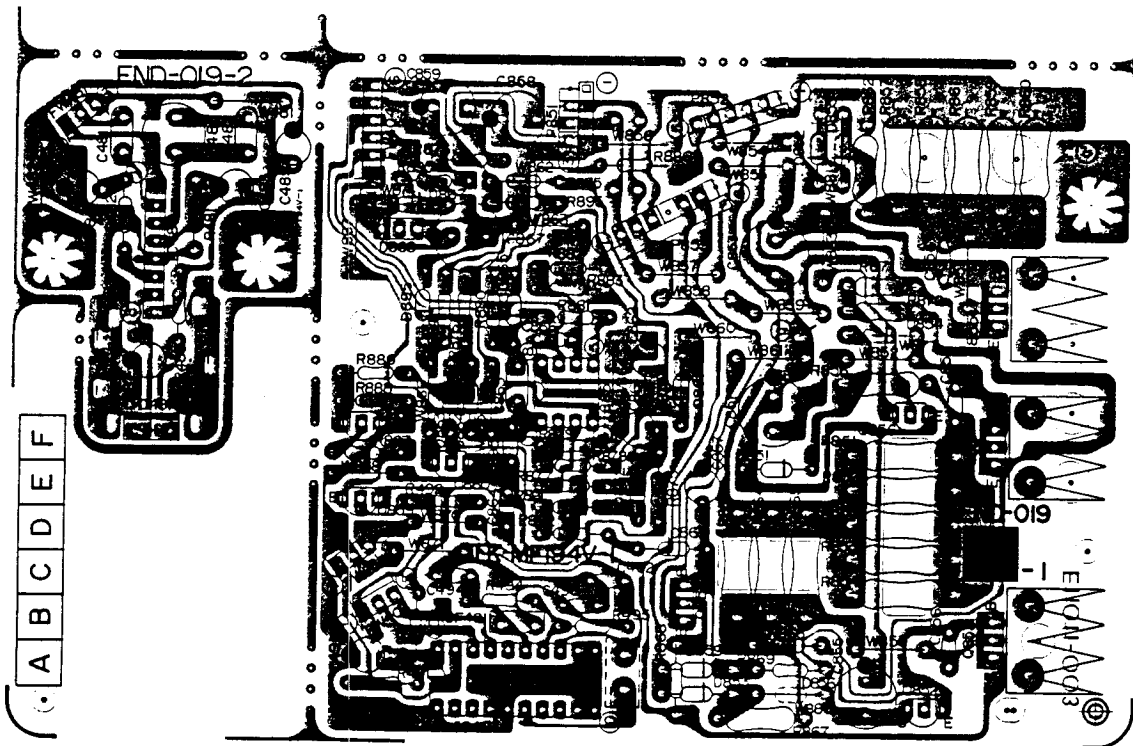

Transistors

Item No.	Part Number	Description	□
		Maker	
Q851	2SD1265A(O,P)	Silicon Matsushita	
Q852	2SC945A(P,Q)	Silicon NEC	
Q853	2SD1265A(O,P)	Silicon Matsushita	
Q854	2SD1265A(O,P)	Silicon Matsushita	
Q855	2SB941A(P,Q)	Silicon Matsushita	
Q856	2SA733A(P,Q)	Silicon NEC	
Q858	2SC458(C,D)	Silicon Hitachi	
Q859	2SA1029(C,D)	Silicon Hitachi	
Q860	2SC458(D)	Silicon Hitachi	

ICs

Item No.	Part Number	Description	□
		Maker	
IC481	UPC1373H		
IC491	M50761-301S	NEC	
IC491	M50761-301S		
IC851	NJM4558D	Dainichi	

Diodes

Item No.	Part Number	Description	□
		Maker	
D481	PH302B	Silicon	
D491	1S2473	Silicon Rohm	
D491	1S2473	Silicon Rohm	
D851	RD18EB3	Silicon NEC	
D852	RD18EB3	Silicon NEC	
D853	RD15EB3	Silicon NEC	
D854	1S2473	Silicon Rohm	D
D855	1S2473	Silicon Rohm	
D856	1S2473	Silicon Rohm	D
D859	RD5.6EB3	Silicon NEC	
D862	1SS108	Silicon Hitachi	
D863	1S2473	Silicon Rohm	
D864	1S2473	Silicon Rohm	
D865	1S2473	Silicon Rohm	
D866	1S2473	Silicon Rohm	
D868	DA203F	Silicon	
D869	1S2473	Silicon Rohm	

For Service Manuals Contact
MAURITRON TECHNICAL SERVICES
 8 Cherry Tree Rd, Chinnor
 Oxon OX9 4QY
 Tel: 01844-351694 Fax: 01844-352554
 Email: enquiries@mauritron.co.uk

R-X500B

Coils

Item No.	Part Number	Description		□
L481	EQL2103-562	Inductor		

Capacitors

Item No.	Part Number	Description		□
C481	QFN31HJ-333	0.033MF	50V Mylar	
C482	QFN31HJ-332	3300PF	50V Mylar	
C483	QETC1EM-106	10MF	25V Electro	
C484	QETC1HM-475	4.7MF	50V Electro	
C485	QETC1EM-106	10MF	25V Electro	
C487	QETC1EM-106	10MF	25V Electro	
C491	QETC1CM-476	47MF	16V Electro	
C492	QCF31HP-223	0.022MF	50V Ceramic	
C493	QCS31HJ-331	330PF	50V Ceramic	
C494	QCS31HJ-331	330PF	50V Ceramic	
C846	QFN31HK-223	0.022MF	50V Mylar	
C846	QFN31HK-223	0.022MF	50V Mylar	
C851	QETB1VM-108	1000MF	35V Electro	
C852	QCF31HP-223	0.022MF	50V Ceramic	
C853	QETB1VM-227	220MF	35V Electro	
C854	QCF31HP-223	0.022MF	50V Ceramic	
C855	QETC1EM-227	220MF	25V Electro	
C856	QCF31HP-223	0.022MF	50V Ceramic	
C857	QETC0JM-107	100MF	6.3V Electro	
C858	QCTC1HM-107	100MF	50V Electro	D
C858	QCTC1HM-476	47MF	50V Electro	C
C859	QCTC1HM-107	100MF	50V Electro	D
C861	QETC1CM-226	22MF	16V Electro	
C862	QETC1AM-477	470MF	10V Electro	
C863	QFN31HK-104	0.1MF	50V Mylar	
C864	QCF31HP-223	0.022MF	50V Ceramic	
C867	QETC1AM-477	470MF	10V Electro	

Resistors

Item No.	Part Number	Description		□
R481	QRD141J-154S	150K	¼W Carbon	
R482	QRD141J-220S	22	¼W Carbon	
R483	QRD141J-102S	1K	¼W Carbon	
R491	QRD141J-104S	100K	¼W Carbon	
R492	QRD141J-563S	56K	¼W Carbon	
R493	QRD141J-102S	1K	¼W Carbon	
△R851	QRG022J-331	330	2W O.M. Film	
△R852	QRG022J-331A	330	2W O.M. Film	
△R853	QRG022J-331A	330	2W O.M. Film	
△R854	QRG022J-471	470	2W O.M. Film	
△R855	QRG022J-561	560	2W O.M. Film	
△R855	QRG022J-561	560	2W O.M. Film	
△R856	QRD125J-152	1.5K	¼W Unf. Carbon	
△R857	QRG022J-331A	330	2W O.M. Film	
△R858	QRG022J-331	330	2W O.M. Film	
△R859	QRG022J-331	330	2W O.M. Film	
△R860	QRG022J-471	470	2W O.M. Film	
△R860	QRG022J-471	470	2W O.M. Film	
△R861	QRG022J-561	560	2W O.M. Film	
△R862	QRD125J-152	1.5K	¼W Unf. Carbon	
△R863	QRG022J-221	220	2W O.M. Film	D
△R863	QRG026J-331	330	2W O.M. Film	
△R864	QRG022J-221	220	2W O.M. Film	D
△R864	QRG026J-331	330	2W O.M. Film	
△R865	QRG022J-221	220	2W O.M. Film	D

△: Safety Parts

Resistors

Item No.	Part Number	Description		□
△R865	QRG026J-331	330	2W O.M. Film	
△R866	QRD145J-101S	100	¼W Unf. Carbon	C
△R866	QRZ0062-101	100	¼W Fusible	D
△R867	QRD125J-222	2.2K	¼W Unf. Carbon	
△R868	QRD145J-101S	100	¼W Unf. Carbon	C
△R868	QRZ0062-101	100	¼W Fusible	D
R869	QRD141J-332S	3.3K	¼W Carbon	
R870	QRD141J-561S	560	¼W Carbon	
R871	QRD141J-562S	5.6K	¼W Carbon	
R871	QRD141J-682S	6.8K	¼W Carbon	
R872	QRD141J-562S	5.6K	¼W Carbon	
R872	QRD141J-562S	5.6K	¼W Carbon	
△R873	QRD145J-181S	180	¼W Unf. Carbon	
R875	QRD141J-563S	56K	¼W Carbon	
R876	QRD141J-563S	56K	¼W Carbon	
R877	QRD141J-563S	56K	¼W Carbon	
R878	QRD141J-563S	56K	¼W Carbon	
R879	QRD141J-104S	100K	¼W Carbon	
R880	QRD141J-154S	150K	¼W Carbon	
R881	QRD141J-563S	56K	¼W Carbon	
R882	QRD141J-563S	56K	¼W Carbon	
R883	QRD141J-563S	56K	¼W Carbon	
R884	QRD141J-103S	10K	¼W Carbon	
R885	QRD141J-103S	10K	¼W Carbon	
R885	QRD141J-103S	10K	¼W Carbon	
R885	QRD141J-223S	22K	¼W Carbon	
R885	QRD141J-223S	22K	¼W Carbon	
R886	QRD141J-103S	10K	¼W Carbon	
R887	QRD141J-103S	10K	¼W Carbon	
R888	QRD141J-184S	180K	¼W Carbon	
R889	QRD141J-334S	330K	¼W Carbon	
R890	QRD141J-182S	1.8K	¼W Carbon	
R891	QRD141J-102S	1K	¼W Carbon	
R891	QRD141J-102S	1K	¼W Carbon	
R891	QRD141J-122S	1.2K	¼W Carbon	
R891	QRD141J-122S	1.2K	¼W Carbon	
R891	QRD141J-563S	56K	¼W Carbon	
R892	QRD141J-102S	1K	¼W Carbon	
R892	QRD141J-102S	1K	¼W Carbon	
R892	QRD141J-105S	1M	¼W Carbon	
R892	QRD141J-471S	470	¼W Carbon	
R892	QRD141J-471S	470	¼W Carbon	
R893	QRD141J-563	56K	¼W Carbon	
R894	QRD141J-105S	1M	¼W Carbon	

△: Safety Parts

Others

Item No.	Part Number	Description	□
	E11011-002	Circuit Board	
	SBSB3012Z	Screw	
	E69826-H40B	Heat Sink	
	E66554-001	Spacer	D
P851	E71504-001	Shield Cover	
P852	E04365-003	3P Socket	
P853	E04365-005	F.W. Socket	
CF491	E04365-006	6P Connector	
	CSB400P	Cera. Lock	

3-(2) ENH-033 □ Audio P.C. Board Ass'y

Note: ENH-033 □ varies according to the areas employed. See note(1) when placing on order.

Note (1)

P.C. Board Ass'y	Designated Areas
ENH-033 A	U.S.A. & Canada
ENH-033 B	U.S. Military Market & Other Countries
ENH-033 C	Europe & Australia
ENH-033 DBS	U.K.
ENH-033 G	West Germany

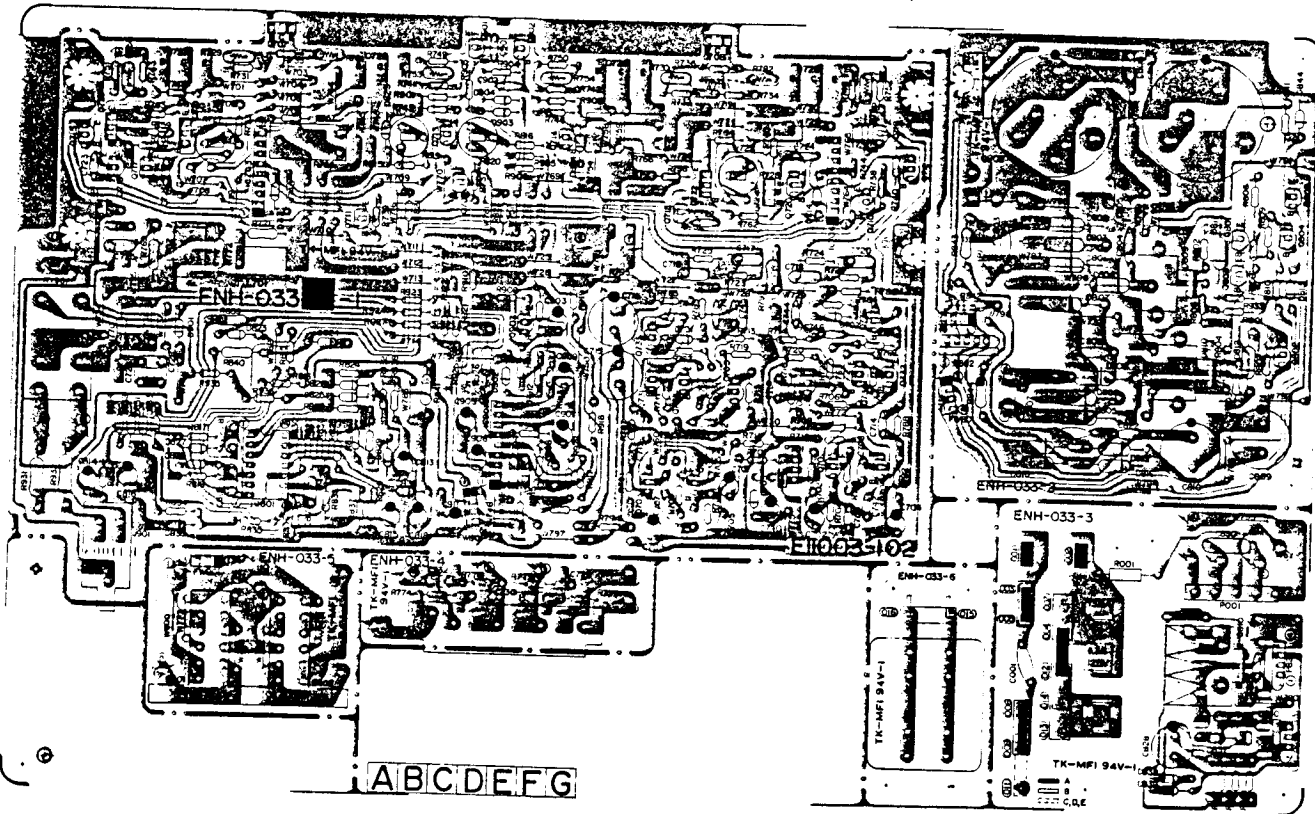

Transistors

Item No.	Part Number	Description		□
			Maker	
Q716	2SA733A(P,Q)	Silicon	NEC	
Q717	2SC2240(GR,BL)	Silicon	Toshiba	
Q718	2SC2240(GR,BL)	Silicon	Toshiba	
Q719	2SA970(GR,BL)	Silicon	Toshiba	
Q720	2SA970(GR,BL)	Silicon	Toshiba	
Q721	2SD669A(B,C)	Silicon	Hitachi	
Q722	2SD669A(B,C)	Silicon	Hitachi	
Q723	2SB649A(B,C)	Silicon	Hitachi	
Q724	2SB649A(B,C)	Silicon	Hitachi	
Q725	2SC2838(O,Y)	Silicon		
Q726	2SC2838(O,Y)	Silicon		
Q727	2SA1187(O,Y)	Silicon		
Q728	2SA1187(O,Y)	Silicon		
Q731	2SA1207(S,T)	Silicon	Sanyo	
Q732	2SA1207(S,T)	Silicon	Sanyo	

Transistors

Item No.	Part Number	Description		□
			Maker	
Q701	2SC2240(A,B)	Silicon	Toshiba	
Q702	2SC2240(A,B)	Silicon	Toshiba	
Q703	2SC2240(A,B)	Silicon	Toshiba	
Q704	2SC2240(A,B)	Silicon	Toshiba	
Q705	2SA1207(S,T)	Silicon	Sanyo	
Q706	2SA1207(S,T)	Silicon	Sanyo	
Q707	2SD636(Q,R)	Silicon	Matsushita	
Q708	2SD636(Q,R)	Silicon	Matsushita	
Q709	2SC945A(P,Q)	Silicon	NEC	
Q710	2SC945A(P,Q)	Silicon	NEC	
Q711	2SA733A(P,Q)	Silicon	NEC	
Q712	2SA733A(P,Q)	Silicon	NEC	
Q713	2SC945A(P,Q)	Silicon	NEC	
Q714	2SC945A(P,Q)	Silicon	NEC	
Q715	2SA733A(P,Q)	Silicon	NEC	

For Service Manuals Contact
MAURITRON TECHNICAL SERVICES
 8 Cherry Tree Rd, Chinnor
 Oxon OX9 4QY
 Tel: 01844-351694 Fax: 01844-352554
 Email: enquiries@mauritron.co.uk

R-X500B

Transistors

Item No.	Part Number	Description		□
			Maker	
Q733	2SA1207(S,T)	Silicon	Sanyo	
Q734	2SA1207(S,T)	Silicon	Sanyo	
Q735	2SC2909(S,T)	Silicon	Sanyo	
Q736	2SC2909(S,T)	Silicon	Sanyo	
Q801	2SC2240(GR,GL)	Silicon	Toshiba	
Q802	2SA970(GR,BL)	Silicon	Toshiba	
Q803	2SA970(GR,BL)	Silicon	Toshiba	
Q804	2SC2240(GR,BL)	Silicon	Toshiba	
Q805	2SC2240(GR,BL)	Silicon	Toshiba	
Q810	2SB941A(P,Q)	Silicon	Matsushita	
Q901	2SC2909(S,T)	Silicon		
Q902	2SC2909(S,T)	Silicon		
Q903	2SA970(GR,BL)	Silicon	Toshiba	

Diodes

Item No.	Part Number	Description		□
			Maker	
D838	RD12EB3	Silicon	NEC	
D839	RD8.2EB3	Silicon	NEC	
D840	1S2473	Silicon	Rohm	
D840	1S2473	Silicon	Rohm	
D840	1S2473	Silicon	Rohm	
D901	1S2473	Silicon	Rohm	
D902	RD5.6EB3	Silicon	NEC	
D903	1S2473	Silicon	Rohm	
D904	1S2473	Silicon	Rohm	

ICs

Item No.	Part Number	Description		□
			Maker	
IC703	VC5022-2		Sanyo	
IC704	VC5022-2		Sanyo	
IC801	AN6912		Matsushita	
IC901	TA7317P		Toshiba	

Coil

Item No.	Part Number	Description	□
L701	EQL0001-1R0	Choke Coil	
L702	EQL0001-1R0	Choke Coil	

Diodes

Item No.	Part Number	Description		□
			Maker	
D701	1S2473	Silicon	Rohm	
D702	1S2473	Silicon	Rohm	
D703	RD18EB3	Silicon	NEC	
D713	1S2473	Silicon	Rohm	
D714	1S2473	Silicon	Rohm	
D801	30DL2FC	Silicon	Nippon Inter	
D802	30DL2FC	Silicon	Nippon Inter	
D803	30DL2FC	Silicon	Nippon Inter	
D804	30DL2FC	Silicon	Nippon Inter	
D805	30DL2FC	Silicon	Nippon Inter	
D806	30DL2FC	Silicon	Nippon Inter	
D807	30DL2FC	Silicon	Nippon Inter	
D808	30DL2FC	Silicon	Nippon Inter	
D809	SF8D41		Toshiba	
D810	SF8D41		Toshiba	
D811	ERB12-02RKL1	Silicon	Fujidenki	
D812	ERB12-02RKL1	Silicon	Fujidenki	
D813	RD6.2EB3	Silicon	NEC	
D814	RD2.7EB2	Silicon	NEC	
D815	ERB12-02RKL1	Silicon	Fujidenki	
D816	ERB12-02RKL1	Silicon	Fujidenki	
D817	ERB12-02RKL1	Silicon	Fujidenki	
D818	ERB12-02RKL1	Silicon	Fujidenki	
D821	1S2473	Silicon	Rohm	
D822	1S2473	Silicon	Rohm	
D823	1S2473	Silicon	Rohm	
D824	1S2473	Silicon	Rohm	
D825	1S2473	Silicon	Rohm	
D826	1S2473	Silicon	Rohm	
D827	1S2473	Silicon	Rohm	
D828	1S2473	Silicon	Rohm	
D829	1S2473	Silicon	Rohm	
D830	1S2473	Silicon	Rohm	
D831	1S2473	Silicon	Rohm	
D832	1S2473	Silicon	Rohm	
D833	1S2473	Silicon	Rohm	
D834	1S2473	Silicon	Rohm	
D835	RD10EB3	Silicon	NEC	
D836	RD15EB3	Silicon	NEC	
D837	RD12EB3	Silicon	NEC	

Capacitors

Item No.	Part Number	Description			□
C001	QCZ9019-472	4700PF		Ceramic	
C701	QET61HM-475	4.7MF	50V	Electro	
C702	QET61HM-475	4.7MF	50V	Electro	
C703	QET61CM-107	100MF	16V	Electro	
C704	QET61CM-107	100MF	16V	Electro	
C705	QCS31HJ-101	100PF	50V	Ceramic	
C706	QCS31HJ-101	100PF	50V	Ceramic	
C707	QCS31HJ-561	560PF	50V	Ceramic	
C708	QCS31HJ-561	560PF	50V	Ceramic	
C709	QCS31HJ-220	22PF	50V	Ceramic	
C710	QCS31HJ-220	22PF	50V	Ceramic	
C711	QCS31HJ-470	47PF	50V	Ceramic	
C712	QCS31HJ-470	47PF	50V	Ceramic	
C713	QCS31HJ-100	10PF	50V	Ceramic	
C714	QCS31HJ-100	10PF	50V	Ceramic	
C715	QET52AM-107	100MF	100V	Electro	
C716	QET52AM-107	100MF	100V	Electro	
C717	QFN31HK-822	8200PF	50V	Mylar	
C718	QFN31HK-822	8200PF	50V	Mylar	
C719	QFN31HK-822	8200PF	50V	Mylar	
C720	QFN31HK-822	8200PF	50V	Mylar	
C721	QCS22HJ-470	47PF	500V	Ceramic	
C722	QCS22HJ-470	47PF	500V	Ceramic	
C723	QCS22HJ-470	47PF	500V	Ceramic	
C724	QCS22HJ-470	47PF	500V	Ceramic	
C725	QFN31HK-473	0.047MF	50V	Mylar	
C726	QFN31HK-473	0.047MF	50V	Mylar	
C727	QFN31HK-473	0.047MF	50V	Mylar	
C727	QFN31HK-473	0.047MF	50V	Mylar	C
C727	QFN31HK-473	0.047MF	50V	Mylar	DBS
C727	QFN31HK-473	0.047MF	50V	Mylar	E
C728	QFN31HK-473	0.047MF	50V	Mylar	
C728	QFN31HK-473	0.047MF	50V	Mylar	C
C728	QFN31HK-473	0.047MF	50V	Mylar	DBS
C728	QFN31HK-473	0.047MF	50V	Mylar	E
C729	QFN31HK-103	0.01MF	50V	Mylar	E
C730	QFN31HK-103	0.01MF	50V	Mylar	E
C731	QFN31HK-103	0.01MF	50V	Mylar	E
C732	QFN31HK-103	0.01MF	50V	Mylar	E
C740	QET61HM-106	10MF	50V	Electro	
C741	QCS31HJ-101	100PF	50V	Ceramic	
C742	QCS31HJ-101	100PF	50V	Ceramic	
C743	QCS31HJ-121	120PF	50V	Ceramic	
C744	QCS31HJ-121	120PF	50V	Ceramic	
C745	QCS31HJ-220	22PF	50V	Ceramic	
C746	QCS31HJ-220	22PF	50V	Ceramic	
C801	EEZ7101-109	1000MF	71V	Electro	

Capacitors

Item No.	Part Number	Description			□
C802	EEZ7101-109	1000MF	71V	Electro	
C803	QCE22HP-103	0.01MF	500V	Ceramic	
C804	QCE22HP103	0.01MF	500V	Ceramic	
C805	QFM32AK-473	0.047MF	100V	Mylar	
C806	QFM32AK-473	0.047MF	100V	Mylar	
C807	QCE22HP-103	0.01MF	500V	Ceramic	
C808	QCE22HP-103	0.01MF	500V	Ceramic	
C809	QETB1HM-108	1000MF	50V	Electro	
C810	QETB1HM-108	1000MF	50V	Electro	
C811	QFN31HK-103	0.01MF	50V	Mylar	
C812	QFN31HK-103	0.01MF	50V	Mylar	
C813	QET61HM-225	2.2MF	50V	Electro	
C814	QET61EM-476	47MF	50V	Electro	
C815	QET62AM-225	2.2MF	100V	Electro	
C816	QET62AM-105	1MF	100V	Electro	
C817	QFN31HK-103	0.01MF	50V	Mylar	
C818	QET61HM-226	22MF	50V	Electro	
C821	QCE22HP-103	0.01MF	500V	Ceramic	
C822	QCE22HP-103	0.01MF	500V	Ceramic	
C827	QCF31HP-223	0.022MF	50V	Ceramic	
C828	QEH61HM-476	47MF	50V	Electro	
C830	QFZ0075-104	0.1MF	400V	M. Mylar	
C901	QCF31HP-223	0.022MF	50V	Ceramic	
C902	QCF31HP-223	0.022MF	50V	Ceramic	
C903	QETC1HM-226	22MF	50V	Electro	
C904	QCY31HK-102	1000PF	50V	Ceramic	
C905	QETC1CM-476	47MF	16V	Electro	
C906	QETC1CM-476	47MF	16V	Electro	
C907	QET61HM-474	0.47MF	50V	Electro	
C908	QFN31HK-153	0.015MF	50V	Mylar	
C909	QET61HM-226	22MF	50V	Electro	
C911	QET61HM-105	1MF	50V	Electro	

Resistors

Item No.	Part Number	Description			□
R001	QRC128K-275E	2.7M	1/2W	Composi	A
R701	QRD141J-222S	2.2K	1/2W	Carbon	
R702	QRD141J-222S	2.2K	1/2W	Carbon	
R703	QRD141J-104S	100K	1/2W	Carbon	
R704	QRD141J-104S	100K	1/2W	Carbon	
R705	QRD141J-202S	2K	1/2W	Carbon	
R706	QRD141J-202S	2K	1/2W	Carbon	
R707	QRD141J-202S	2K	1/2W	Carbon	
R708	QRD141J-202S	2K	1/2W	Carbon	
R709	QRD141J-330S	33	1/2W	Carbon	
R710	QRD141J-330S	33	1/2W	Carbon	
R711	QRD141J-472S	4.7K	1/2W	Carbon	
R712	QRD141J-472S	4.7K	1/2W	Carbon	
R713	QRD141J-272S	2.7K	1/2W	Carbon	
R714	QRD141J-272S	2.7K	1/2W	Carbon	
△R715	QRD145J-121S	120	1/2W	Unf. Carbon	
△R716	QRD145J-121S	120	1/2W	Unf. Carbon	
R717	QRD141J-152S	1.5K	1/2W	Carbon	
R718	QRD141J-152S	1.5K	1/2W	Carbon	
R719	QRD141J-393S	39K	1/2W	Carbon	
R720	QRD141J-393S	39K	1/2W	Carbon	
R721	QRD141J-392S	3.9K	1/2W	Carbon	
R722	QRD141J-392S	3.9K	1/2W	Carbon	
R723	QRD141J-682S	6.8K	1/2W	Carbon	
R724	QRD141J-682S	6.8K	1/2W	Carbon	
R725	QRD141J-682S	6.8K	1/2W	Carbon	
R726	QRD141J-682S	6.8K	1/2W	Carbon	
R727	QVP4A0B-471	470	0.1W	Variable	
R728	QVP4A0B-471	470	0.1W	Variable	
R729	ERT-D2WFL351S			Termister	

△: Safety Parts

Resistors

Item No.	Part Number	Description			□
R730	ERT-D2WFL351S			Termister	
R731	QRD141J-101S	100	1/2W	Carbon	
R732	QRD141J-101S	100	1/2W	Carbon	
R733	QRD141J-471S	470	1/2W	Carbon	
R734	QRD141J-471S	470	1/2W	Carbon	
R735	QRD141J-391S	390	1/2W	Carbon	
R736	QRD141J-391S	390	1/2W	Carbon	
R737	QRD141J-102S	1K	1/2W	Carbon	
R738	QRD141J-102S	1K	1/2W	Carbon	
R739	QRD141J-102S	1K	1/2W	Carbon	
R740	QRD141J-102S	1K	1/2W	Carbon	
R741	QRD141J-111S	110	1/2W	Carbon	
R742	QRD141J-111S	110	1/2W	Carbon	
R743	QRD141J-111S	110	1/2W	Carbon	
R744	QRD141J-111S	110	1/2W	Carbon	
R745	QRD141J-151S	150	1/2W	Carbon	
R746	QRD141J-151S	150	1/2W	Carbon	
R747	QRD141J-151S	150	1/2W	Carbon	
R748	QRD141J-151S	150	1/2W	Carbon	
R749	QRD141J-820S	82	1/2W	Carbon	
R750	QRD141J-820S	82	1/2W	Carbon	
R751	QRD141J-820S	82	1/2W	Carbon	
R752	QRD141J-820S	82	1/2W	Carbon	
R753	ERT-D2WFL351S			Termister	
R754	ERT-D2WFL351S			Termister	
R755	ERT-D2WFL351S			Termister	
R756	ERT-D2WFL351S			Termister	
△R757	QRD145J-100S	10	1/2W	Unf. Carbon	
△R758	QRD145J-100S	10	1/2W	Unf. Carbon	
△R759	QRD145J-100S	10	1/2W	Unf. Carbon	
△R760	QRD145J-100S	10	1/2W	Unf. Carbon	
△R761	QRD145J-272S	2.7K	1/2W	Unf. Carbon	
△R762	QRD145J-272S	2.7K	1/2W	Unf. Carbon	
△R763	QRD145J-271S	270	1/2W	Unf. Carbon	
△R764	QRD145J-271S	270	1/2W	Unf. Carbon	
R765	ERF032K-R22	0.22	3W	Cemment	
R766	ERF032K-R22	0.22	3W	Cemment	
R767	QRD141J-392S	3.9K	1/2W	Carbon	
R768	QRD141J-392S	3.9K	1/2W	Carbon	
△R769	QRG022J-100A	10	2W	O.M. Film	
△R770	QRG022J-100A	10	2W	O.M. Film	
△R771	QRD125J-330	33	1/2W	Unf. Carbon	
△R772	QRD125J-330	33	1/2W	Unf. Carbon	
△R773	QRZ0062-100	10	1/2W	Fusible	E
△R774	QRZ0062-100	10	1/2W	Fusible	E
△R775	QRZ0062-100	10	1/2W	Fusible	E
△R776	QRZ0062-100	10	1/2W	Fusible	E
R781	SDT250			Termister	C
R781	SDT250			Termister	DBS
R781	SDT250			Termister	E
R782	SDT250			Termister	C
R782	SDT250			Termister	DBS
R782	SDT250			Termister	E
R783	QRD141J-271S	270	1/2W	Carbon	
R784	QRD141J-271S	270	1/2W	Carbon	
R785	QRD141J-271S	270	1/2W	Carbon	
R786	QRD141J-271S	270	1/2W	Carbon	
R787	QRD141J-104S	100K	1/2W	Carbon	
R788	QRD141J-104S	100K	1/2W	Carbon	
R791	QRD141J-821S	820	1/2W	Carbon	
R792	QRD141J-821S	820	1/2W	Carbon	
△R793	QRG012J-562A	5.6K	1W	O.M. Film	
△R794	QRD145J-680S	68	1/2W	Unf. Carbon	
△R795	QRD145J-680S	68	1/2W	Unf. Carbon	
R801	QRD141J-822S	8.2K	1/2W	Carbon	
△R802	QRD145J-4R7S	4.7	1/2W	Unf. Carbon	
△R803	QRD145J-4R7S	4.7	1/2W	Unf. Carbon	
R804	QRD141J-333S	33K	1/2W	Carbon	
R805	QRD141J-333S	33K	1/2W	Carbon	
R806	QRD141J-472S	4.7K	1/2W	Carbon	

△: Safety Parts

Resistors

Item No.	Part Number	Description			□
R807	QRD141J-472S	4.7K	¼W	Carbon	
R808	QRD141J-103S	10K	¼W	Carbon	
R809	QRD141J-122S	1.2K	¼W	Carbon	
R810	QRD141J-103S	10K	¼W	Carbon	
R813	QRV144F-4702	47K	¼W	Carbon	
R814	QRV144F-4702	47K	¼W	Carbon	
R815	QRV144F-4702	47K	¼W	Carbon	
R816	QRV144F-4702	47K	¼W	Carbon	
R817	QRD141J-472S	4.7K	¼W	Carbon	
R818	QRD141J-472S	4.7K	¼W	Carbon	
R819	QVP4A0B-472	4.7K	0.1W	Variable	
R820	QVP4A0B-472	4.7K	0.1W	Variable	
R821	QRD141J-472S	4.7K	¼W	Carbon	
R822	QRD141J-472S	4.7K	¼W	Carbon	
R823	QRD141J-153S	15K	¼W	Carbon	
R824	QRD141J-153S	15K	¼W	Carbon	
R825	QRD141J-472S	4.7K	¼W	Carbon	
R826	QRD141J-472S	4.7K	¼W	Carbon	
R827	QRD148J-185S	1.8M	¼W	Carbon	
R828	QRD141J-472S	4.7K	¼W	Carbon	
R829	QRD141J-271S	270	¼W	Carbon	
R830	QRD141J-154S	150K	¼W	Carbon	
R831	QRD141J-474S	470K	¼W	Carbon	
R832	QRD141J-224S	220K	¼W	Carbon	
R833	QRD141J-823S	82K	¼W	Carbon	
R834	QRD141J-223S	22K	¼W	Carbon	
R835	QRD141J-563S	56K	¼W	Carbon	
R836	QRD141J-473S	47K	¼W	Carbon	
R837	QRD141J-153S	15K	¼W	Carbon	
R838	QRD141J-474S	470K	¼W	Carbon	
△ R839	QRD145J-101S	100	¼W	Unf. Carbon	
△ R840	QRD145J-101S	100	¼W	Unf. Carbon	
△ R841	QRG012J-222A	2.2K	1W	O.M. Film	
R842	QRD141J-822S	8.2K	¼W	Carbon	
△ R843	QRD125J-2R2	2.2	¼W	Unf. Carbon	
△ R844	QRD125J-2R2	2.2	¼W	Unf. Carbon	
△ R845	QRD125J-102	1K	¼W	Unf. Carbon	
△ R847	QRD145J-680S	68	¼W	Unf. Carbon	A
△ R847	QRD145J-680S	68	¼W	Unf. Carbon	B
△ R847	QRZ0062-680	68	¼W	Fusible	C
△ R847	QRZ0062-680	68	¼W	Fusible	DBS
△ R847	QRZ0062-680	68	¼W	Fusible	E
△ R848	QRD145J-680S	68	¼W	Unf. Carbon	A
△ R848	QRD145J-680S	68	¼W	Unf. Carbon	B
△ R848	QRZ0062-680	68	¼W	Fusible	C
△ R848	QRZ0062-680	68	¼W	Fusible	DBS
△ R848	QRZ0062-680	68	¼W	Fusible	E
△ R849	QRD145J-680S	68	¼W	Unf. Carbon	A
△ R849	QRD145J-680S	68	¼W	Unf. Carbon	B
△ R849	QRZ0062-680	68	¼W	Fusible	C
△ R849	QRZ0062-680	68	¼W	Fusible	DBS
△ R849	QRZ0062-680	68	¼W	Fusible	E
R901	QRD141J-681S	680	¼W	Carbon	
R902	QRD141J-681S	680	¼W	Carbon	
R903	QRD141J-562S	5.6K	¼W	Carbon	
R904	QRD141J-562S	5.6K	¼W	Carbon	
R905	QRD141J-123S	12K	¼W	Carbon	
R906	QRD141J-123S	12K	¼W	Carbon	
R907	QRD141J-103S	10K	¼W	Carbon	
R908	QRD141J-332S	3.3K	¼W	Carbon	
R909	QRD141J-473S	47K	¼W	Carbon	
△ R910	QRD145J-221S	220	¼W	Unf. Carbon	
R911	QRD141J-682S	6.8K	¼W	Carbon	
R912	QRD141J-682S	6.8K	¼W	Carbon	
R913	QRD141J-152S	1.5K	¼W	Carbon	
R914	QRD141J-224S	220K	¼W	Carbon	
R915	QRD141J-333S	33K	¼W	Carbon	
R916	QRD141J-683S	68K	¼W	Carbon	
R917	QRD141J-392S	3.9K	¼W	Carbon	
R918	QRD141J-472S	4.7K	¼W	Carbon	

△: Safety Parts

Resistors

Item No.	Part Number	Description			□
R919	QRD141J-472S	4.7K	¼W	Carbon	
R920	QRD141J-563S	56K	¼W	Carbon	
R921	QRD141J-273S	27K	¼W	Carbon	
R922	QRD141J-273S	27K	¼W	Carbon	
R923	QRD141J-563S	56K	¼W	Carbon	
R924	QRD141J-563S	56K	¼W	Carbon	
△ R925	QRG022J-821A	820	2W	O.M. Film	
△ R926	QRG022J-681A	680	2W	O.M. Film	
R927	QRD141J-560S	56	¼W	Carbon	
R928	QRD141J-683S	68K	¼W	Carbon	
△ R931	QRG022J-331A	330	2W	O.M. Film	
△ R932	QRG022J-331A	330	2W	O.M. Film	
R935	QRD141J-680S	68	¼W	Carbon	
R936	QRD141J-330S	33	¼W	Carbon	

△: Safety Parts

Others

Item No.	Part Number	Description	□
	EMV5102-005A	5P Plug Ass'y	
	E04365-005	F.W. Socket	
	QMC0437-002	AC Socket △	A
	QMC0437-002	AC Socket △	B
	E45524-002	Fuse Clip	A
	EMB90TV-801A	Speaker Terminal	
	E67764-102	Terminal Ass'y	
	E67764-103	Terminal Ass'y	B
	E67764-202	Terminal Ass'y	A
	E67764-203	Terminal Ass'y	B
	E67764-203	Terminal Ass'y	C
	E67764-203	Terminal Ass'y	D
	E67764-203	Terminal Ass'y	E
	E67764-302	Terminal Ass'y	A
	E67764-302	Terminal Ass'y	B
	E65508-002	TAB	
	EMG7331-001	Fuse Clip	C
	EMG7331-001	Fuse Clip	D
	EMB7331-001	Fuse Clip	E
	E11003-101	Circuit Board	A
	E11003-101	Circuit Board	B
	E11003-101	Circuit Board	C
	E11003-101	Circuit Board	E
	E11003-101BS	Circuit Board	D
	E302256-003	Heat Sink Bracket	
	E302256-004	Heat Sink Bracket	
	E33754-001	Tie Band	
	SBSB3008Z	Screw	
	SBSB3010Z	Screw	
	SBSB3012Z	Screw	
	E302267-002	Heat Sink	
	E69826-025B	Heat Sink	
	E70859-001	Earth Plate	
J901	QMS6302-125	Headphone Jack	
P701	E04365-003	3P Socket	
P821	E04365-004	Jumper Socket	
P822	E04365-003	3P Socket	
S801	QST4261-E06	Push Switch	
RY901	ESK5D24-214	Relay	

△: Safety Parts

△: Safety Parts

The column marked with □ indicates the Area.
 Parts without character in the column are used commonly regardless of delivery area.

3-(3) ENB-015 □ L.C. Display P.C. Board Ass'y

Note: ENB-015 □ varies according to the areas employed. See note(1) when placing on order.

Note (1)

P.C. Board Ass'y	Designated Areas
ENB-015 <input type="checkbox"/> D	U.S.A. & Canada
ENB-015 <input type="checkbox"/> E	U.S. Military Market & Other Countries
ENB-015 <input type="checkbox"/> F	Europe, Australia, U.K. & West Germany

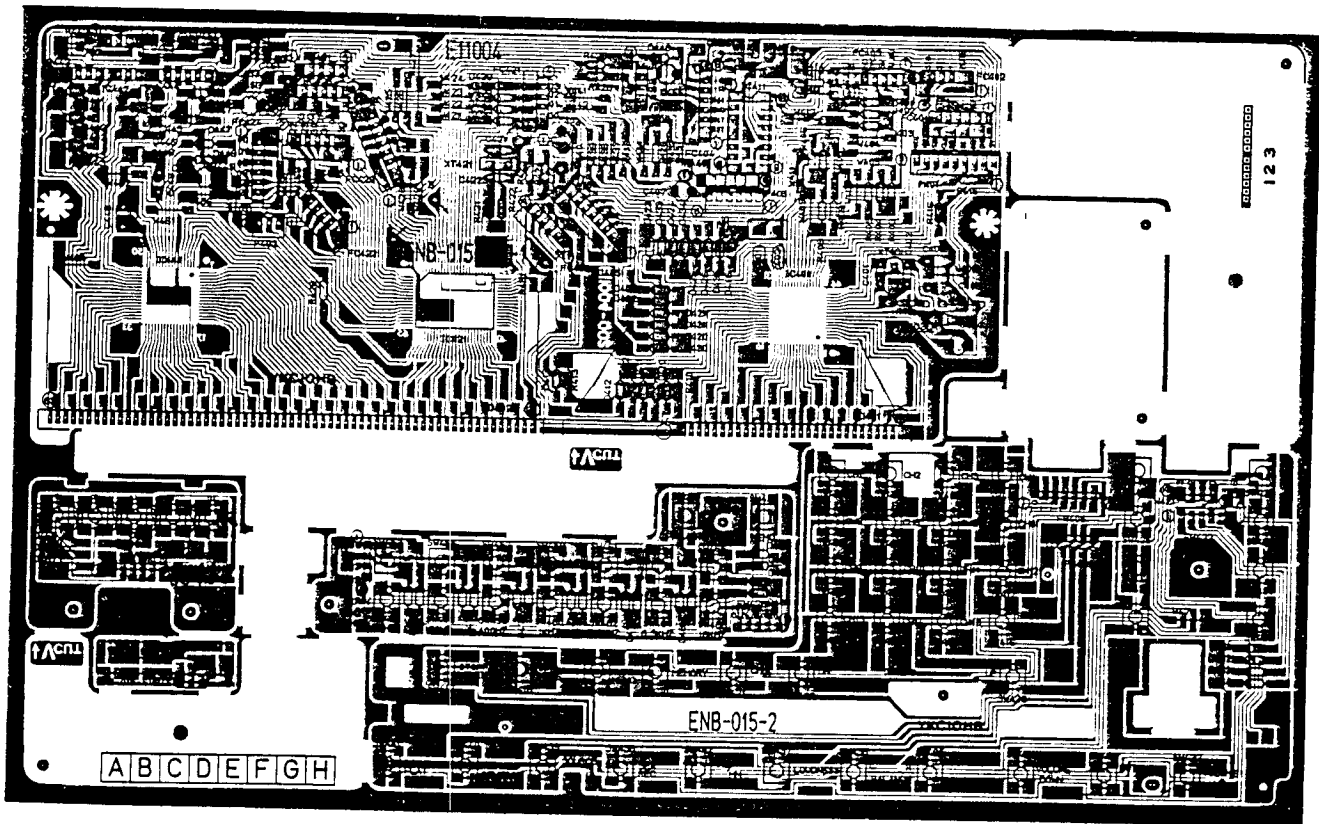

For Service Manuals Contact
MAURITRON TECHNICAL SERVICES
 8 Cherry Tree Rd, Chinnor
 Oxon OX9 4QY
 Tel: 01844-351694 Fax: 01844-352554
 Email: enquiries@mauritron.co.uk

ICs

Item No.	Part Number	Description		□
			Maker	
IC401	TC9302F-002		Toshiba	
IC411	TC9173P		Toshiba	
IC421	HD44790-A89		Hitachi	
IC441	LC7560		Sanyo	
IC442	SAB2-027		Alps	

Diodes

Item No.	Part Number	Description		□
			Maker	
D401	1S2473	Silicon	Rohm	
D402	1S2473	Silicon	Rohm	
D403	1S2473	Silicon	Rohm	
D410	1S2473	Silicon	Rohm	
D411	1S2473	Silicon	Rohm	
D412	1S2473	Silicon	Rohm	
D413	1S2473	Silicon	Rohm	
D420	1S2473	Silicon	Rohm	
D421	1S2473	Silicon	Rohm	
D422	1S2473	Silicon	Rohm	
D423	1S2473	Silicon	Rohm	
D424	1S2473	Silicon	Rohm	
D425	1S2473	Silicon	Rohm	
D426	1S2473	Silicon	Rohm	
D430	1S2473	Silicon	Rohm	E
D430	1S2473	Silicon	Rohm	F
D431	1S2473	Silicon	Rohm	D
D434	1S2473	Silicon	Rohm	D
D434	1S2473	Silicon	Rohm	E
D435	1S2473	Silicon	Rohm	E
D435	1S2473	Silicon	Rohm	F
D436	1S2473	Silicon	Rohm	
D437	1S2473	Silicon	Rohm	
D438	1S2473	Silicon	Rohm	
D439	1S2473	Silicon	Rohm	
D441	1S2473	Silicon	Rohm	
D442	1S2473	Silicon	Rohm	
D443	1S2473	Silicon	Rohm	
D444	1S2473	Silicon	Rohm	
D445	1S2473	Silicon	Rohm	
D446	1S2473	Silicon	Rohm	
D447	1S2473	Silicon	Rohm	
D448	RD13EB3	Silicon	NEC	
D449	1S2473	Silicon	Rohm	
D460	1S2473	Silicon	Rohm	
D461	1S2473	Silicon	Rohm	
D462	1S2473	Silicon	Rohm	
D463	1S2473	Silicon	Rohm	
D464	1S2473	Silicon	Rohm	
D465	1S2473	Silicon	Rohm	
D466	1S2473	Silicon	Rohm	
D467	1S2473	Silicon	Rohm	
D468	1S2473	Silicon	Rohm	
D469	1S2473	Silicon	Rohm	
D471	1S2473	Silicon	Rohm	
D472	1S2473	Silicon	Rohm	
D473	1S2473	Silicon	Rohm	
D474	1S2473	Silicon	Rohm	
D475	1S2473	Silicon	Rohm	
D476	1S2473	Silicon	Rohm	
D477	1S2473	Silicon	Rohm	
D478	1S2473	Silicon	Rohm	
D479	1S2473	Silicon	Rohm	
D480	1S2473	Silicon	Rohm	
D481	1S2473	Silicon	Rohm	
D482	1S2473	Silicon	Rohm	
D483	1S2473	Silicon	Rohm	
D484	1S2473	Silicon	Rohm	
D485	1S2473	Silicon	Rohm	
D486	1S2473	Silicon	Rohm	

Capacitors

Item No.	Part Number	Description			□
C401	QCS31HJ-120	12PF	50V	Ceramic	
C402	QCS31HJ-120	12PF	50V	Ceramic	
C403	QCS61AM-107	100MF	10V	Electro	
C403	QET61AM-107	100MF	10V	Electro	
C404	QCF31HP-223	0.022MF	50V	Ceramic	
C405	QCF31HP-223	0.022MF	50V	Ceramic	
C407	QET61EM-106	10MF	25V	Electro	
C421	QCS31HJ-331	330PF	50V	Ceramic	
C422	QCS31HJ-331	330PF	50V	Ceramic	
C423	QET61AM-476	47MF	10V	Electro	
C441	QET61HM-474	0.47MF	50V	Electro	
C442	QET61HM-474	0.47MF	50V	Electro	
C443	QET61HM-474	0.47MF	50V	Electro	
C444	QET61HM-474	0.47MF	50V	Electro	
C445	QET61HM-474	0.47MF	50V	Electro	
C446	QET61HM-474	0.47MF	50V	Electro	
C447	QET61HM-474	0.47MF	50V	Electro	
C448	QFN31HK-103	0.01MF	50V	Mylar	
C449	QCF31HP-223	0.022MF	50V	Ceramic	
C452	QET61EM-106	10MF	25V	Electro	
C455	QET61EM-106	10MF	25V	Electro	
C456	QET61HM-475	4.7MF	50V	Electro	

Resistors

Item No.	Part Number	Description			□
R403	QRD141J-332S	3.3K	¼W	Carbon	
R404	QRD141J-222S	2.2K	¼W	Carbon	
R405	QRD141J-104S	100K	¼W	Carbon	
R407	QRD141J-104S	100K	¼W	Carbon	
R408	QRD141J-104S	100K	¼W	Carbon	
R415	QRD141J-103S	10K	¼W	Carbon	
R416	QRD141J-473S	47K	¼W	Carbon	
R417	QRD141J-102S	1K	¼W	Carbon	
R421	QRD141J-105S	1M	¼W	Carbon	
R422	QRD141J-222S	2.2K	¼W	Carbon	
R423	QRD141J-102S	1K	¼W	Carbon	
R424	QRD141J-102S	1K	¼W	Carbon	
R425	QRD141J-563S	56K	¼W	Carbon	
R426	QRD141J-563S	56K	¼W	Carbon	
R428	QRD141J-104S	100K	¼W	Carbon	
R429	QRD141J-560S	56	¼W	Carbon	
R441	QRD141J-273S	27K	¼W	Carbon	
R442	QRD141J-332S	3.3K	¼W	Carbon	
R443	QRD141J-332S	3.3K	¼W	Carbon	
R444	QRD141J-273S	27K	¼W	Carbon	
R445	QRD141J-331S	330	¼W	Carbon	
VR451	QVZ5310-001			Variable	

Others

Item No	Part Number	Description	□
	E11004-002	Circuit Board	
	E67764-002	Terminal Ass'y	
	E67910-001	Spacer	D
P401	QMV5005-009K	9P Plug Ass'y	
P402	QMV5005-003K	3P Plug Ass'y	
P403	QMV5005-006K	6P Plug Ass'y	
FC401	E04365-005	F.W. Socket	
FC402	E04365-004	Jumper Socket	
FC403	E04365-006	6P Connector	
FC404	E04365-006	6P Connector	

Others

Item No.	Part Number	Description	<input type="checkbox"/>
FC405	E04365-007	F.W. Socket	
FC406	E04365-004	Jumper Socket	
FC407	E04365-003	3P Socket	
FC407	E04365-003	3P Socket	
FC407	E04365-003	3P Socket	
FC421	E04365-004	Jumper Socket	
FC422	E04365-005	F.W. Socket	
FC423	E04365-007	F.W. Socket	
FC424	E04365-006	6P Connector	
FC425	E04365-004	Jumper Socket	
FC426	E04365-005	F.W. Socket	
FC441	E04365-003	3P Socket	
SW401	ESP0001-007	Push Switch	
SW402	ESP0001-007	Push Switch	
SW403	ESP0001-007	Push Switch	
SW404	ESP0001-007	Push Switch	
SW405	ESP0001-007	Push Switch	
SW406	ESP0001-007	Push Switch	
SW407	ESP0001-007	Push Switch	
SW408	ESP0001-007	Push Switch	
SW409	ESP0001-007	Push Switch	
SW410	ESP0001-007	Push Switch	
SW411	ESP0001-007	Push Switch	
SW412	ESP0001-007	Push Switch	
SW413	ESP0001-007	Push Switch	
SW414	ESP0001-007	Push Switch	
SW415	ESP0001-007	Push Switch	
SW416	ESP0001-007	Push Switch	
SW417	ESP0001-007	Push Switch	
SW418	ESP0001-007	Push Switch	
SW419	ESP0001-007	Push Switch	
SW420	ESP0001-007	Push Switch	
SW421	ESP0001-007	Push Switch	
SW422	ESP0001-007	Push Switch	
SW423	ESP0001-007	Push Switch	
SW424	ESP0001-007	Push Switch	
SW425	ESP0001-007	Push Switch	
SW426	ESP0001-007	Push Switch	
SW427	ESP0001-007	Push Switch	
SW428	ESP0001-007	Push Switch	
SW429	ESP0001-007	Push Switch	
SW430	ESP0001-007	Push Switch	
SW431	ESP0001-007	Push Switch	
SW432	ESP0001-007	Push Switch	
SW433	ESP0001-007	Push Switch	
SW434	ESP0001-007	Push Switch	
SW435	ESP0001-007	Push Switch	
SW436	ESP0001-007	Push Switch	
SW437	ESP0001-007	Push Switch	
SW438	ESP0001-007	Push Switch	
SW439	ESP0001-007	Push Switch	
SW440	ESP0001-007	Push Switch	
SW441	ESP0001-007	Push Switch	
SW442	ESP0001-007	Push Switch	
SW451	ESP0001-007	Push Switch	
SW452	ESP0001-007	Push Switch	
SW453	ESP0001-007	Push Switch	
SW454	ESP0001-007	Push Switch	
SW455	ESP0001-007	Push Switch	
SW456	ESP0001-007	Push Switch	
SW457	ESP0001-007	Push Switch	
SW458	ESP0001-007	Push Switch	
SW459	ESP0001-007	Push Switch	
SW460	ESP0001-007	Push Switch	
SW461	ESP0001-007	Push Switch	
SW462	ESP0001-007	Push Switch	
SW463	ESP0001-007	Push Switch	
SW464	ESP0001-007	Push Switch	
SW465	ESP0001-007	Push Switch	
SW466	ESP0001-007	Push Switch	

Others

Item No.	Part Number	Description	<input type="checkbox"/>
SW471	ESP0001-007	Push Switch	
SW472	ESP0001-007	Push Switch	
SW473	ESP0001-007	Push Switch	
SW474	ESP0001-007	Push Switch	
SW475	ESP0001-007	Push Switch	
XT401	ECX0007-200KC	Crystal	
XT421	CSB400P	Cera. Lock	
RA411	ERGS5XK-104	Resistor Array	
RA421	ERGS4XK-104	Resistor Array	
LD401	ELU0002-004	FL Tube	
LD402	ELU0002-005	FL Tube	

△ : Safety Parts

The column marked with indicates the Area.

Parts without character in the column are used commonly regardless of delivery area.

For Service Manuals Contact
MAURITRON TECHNICAL SERVICES
 8 Cherry Tree Rd, Chinnor
 Oxon OX9 4QY
 Tel:- 01844-351694 Fax:- 01844-352554
 Email:- enquiries@mauritron.co.uk

3-(4) ENA-023 Tuner P.C. Board Ass'y

Note: ENA-023 varies according to the areas employed. See note(1) when placing on order.

Note (1)

P.C. Board Ass'y	Designated Areas
ENA-023 F	U.S.A. & Canada
ENA-023 G	U.S. Military Market & Other Countries
ENA-023 H	Europe, Australia & U.K.
ENA-023 I	West Germany

For Service Manuals Contact
MAURITRON TECHNICAL SERVICES
 8 Cherry Tree Rd, Chinnor
 Oxon OX9 4QY
 Tel:- 01844-351694 Fax:- 01844-352554
 Email:- enquiries@mauritron.co.uk

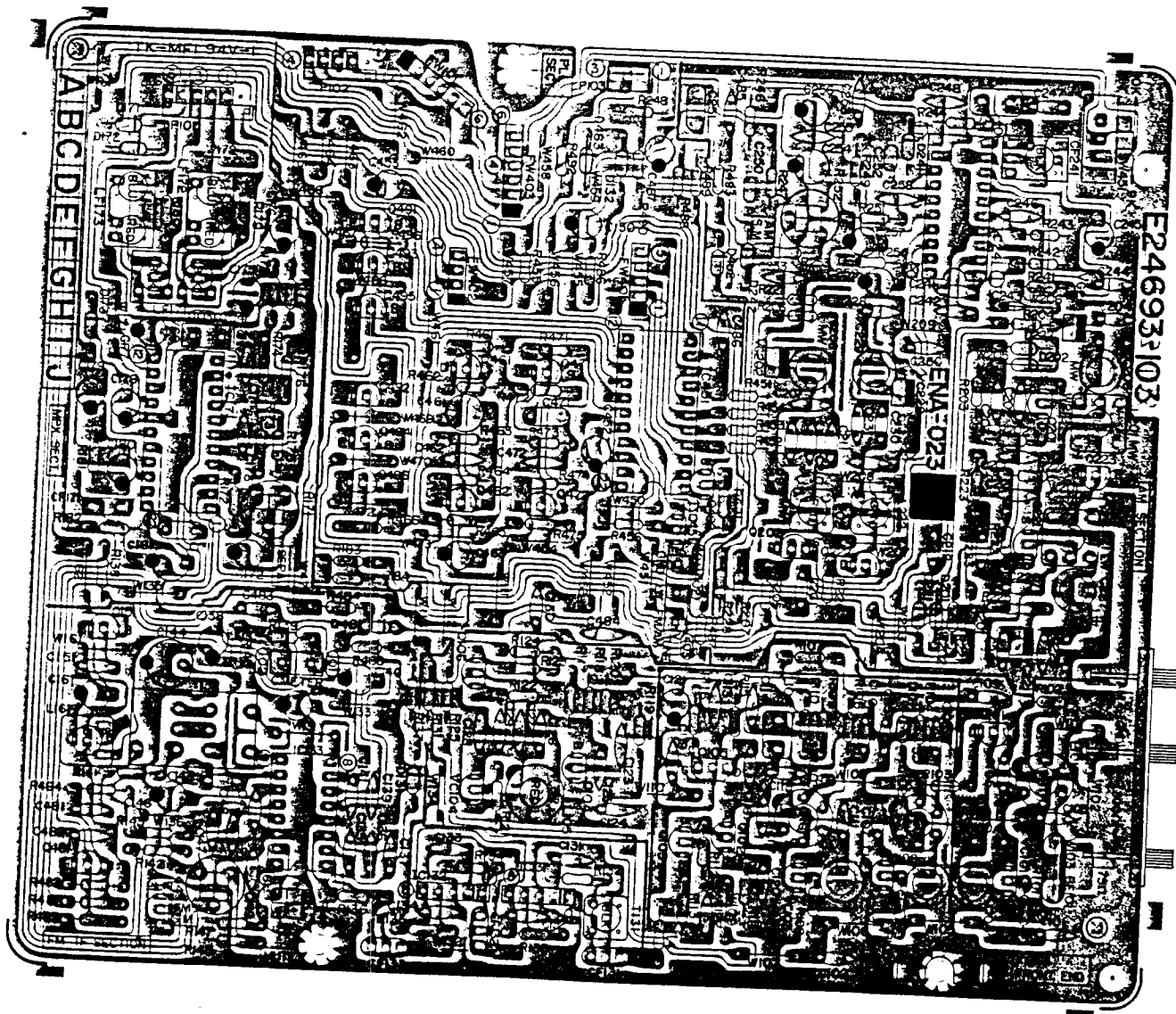

Transistors

Item No.	Part Number	Description		□
			Maker	
Q101	2SK359(E,F)	F.E.T.		
Q102	2SC535(B)	Silicon	Hitachi	
Q103	2SC461(B,C)	Silicon	Hitachi	
Q104	2SC461(B,C)	Silicon	Hitachi	
Q105	2SK161(GR)	F.E.T.	Toshiba	
Q105	2SK161(GR)	F.E.T.	Toshiba	
Q106	2SK168(E)	F.E.T.		
Q131	DTC144N	Silicon	Rohm	
Q151	DTC144N	Silicon	Rohm	
Q201	2SK105(F,H)	F.E.T.	NEC	
Q451	DTC114YN	Silicon	Rohm	
Q461	2SK105(1)	F.E.T.	NEC	
Q462	2SC1815(Y,GR)	Silicon	Toshiba	
Q481	2SC535(B)	Silicon	Hitachi	
Q482	2SC1815(Y,GR)	Silicon	Toshiba	
Q491	DTC144N	Silicon	Rohm	
Q492	DTA114YN	Silicon	Rohm	
Q493	DTC144N	Silicon	Rohm	
Q494	DTA114YN	Silicon	Rohm	

ICs

Item No.	Part Number	Description		□
			Maker	
IC131	BA401			
IC132	BA401			
IC133	LA1235B		Sanyo	
IC171	LA3400		Sanyo	
IC241	LA1245		Sanyo	
IC451	TC9171P		Toshiba	

Diodes

Item No.	Part Number	Description		□
			Maker	
D101	1SS108	Silicon	Hitachi	
D131	1S2473	Silicon	Rohm	
D172	1S2473	Silicon	Rohm	
D173	1S2473	Silicon	Rohm	
D174	1S2473	Silicon	Rohm	
D241	1SS108	Silicon	Hitachi	
D242	1S2473	Silicon	Rohm	
D481	1S2222	Silicon	NEC	
D482	1S2473	Silicon	Rohm	
D483	1S2473	Silicon	Rohm	
D484	1S2473	Silicon	Rohm	
VC101	SVC202(AB)	Silicon	Sanyo	
VC102	SVC202(AB)	Silicon	Toshiba	
VC103	SVC202(AB)	Silicon	Sanyo	
VC104	SVC202(AB)	Silicon	Sanyo	
VC201	KV1236Z	Silicon	Tokyo	

Coils

Item No.	Part Number	Description		□
L101	EQR2304-004	RF Coil		
L101	EQR2304-005	OSC Coil		I
L101	EQR2304-005	OSC Coil		F
L101	EQR2304-005	OSC Coil		G
L101	EQR2304-005	OSC Coil		H
L102	EQR2304-012	RF Coil		
L103	EQR2304-013	RF Coil		
L104	EQL3001-1R5K	Inductor		
L105	EQR2404-004	RF Coil		
L201	EQR1111-006	RF Coil		
L202	EQR1207-003	RF Coil		
L241	EQL3001-102K	Inductor		
T131	EQT2121-005	I.F. Transformer		
T132	EQT2140-003	I.F. Transformer		

Capacitors

Item No.	Part Number	Description			□
C101	QCF31HP-223	0.022MF	50V	Ceramic	
C102	QCF31HP-223	0.022MF	50V	Ceramic	
C103	QCF31HP-223	0.022MF	50V	Ceramic	E
C104	ENZ1003-002			Trimmer	
C106	QCF31HP-103	0.01MF	50V	Ceramic	
C107	QCS31HJ-5R0	5.0PF	50V	Ceramic	
C108	ENZ1003-002			Trimmer	
C111	QCS31HJ-5R0	5.0PF	50V	Ceramic	
C112	ENZ1003-002			Trimmer	
C113	QCF31HP-103	0.01MF	50V	Ceramic	
C114	QCS31HJ-151	150PF	50V	Ceramic	
C115	QCF31HP-103	0.01MF	50V	Ceramic	
C116	QCS31HJ-5R0	5.0PF	50V	Ceramic	
C117	QCS31HJ-7R0	7.0PF	50V	Ceramic	F
C117	QCS31HJ-7R0	7.0PF	50V	Ceramic	G
C117	QCS31HJ-7R0	7.0PF	50V	Ceramic	H
C117	QCS31HJ-2R0	2.0PF	50V	Ceramic	I
C119	QCS31HJ-4R0	4.0PF	50V	Ceramic	
C120	QCF31HP-103	0.01MF	50V	Ceramic	
C121	QETC1CM-476	47MF	16V	Electro	
C122	QCF31HP-223	0.022MF	50V	Ceramic	
C123	QCF31HP-103	0.01MF	50V	Ceramic	
C124	QCT25UJ-100	10PF	50V	Ceramic	
C125	QCT25UJ-220	22PF	50V	Ceramic	
C126	QCS31HJ-7R0	7.0PF	50V	Ceramic	
C127	QCT25UJ-5R0	5.0PF	50V	Ceramic	
C128	QCT25UJ-5R0	5.0PF	50V	Ceramic	
C129	QCT25CH-2R0	2.0PF	50V	Ceramic	
C130	QCF31HP-103	0.01MF	50V	Ceramic	
C131	QCF31HP-223	0.022MF	50V	Ceramic	
C132	QCF31HP-223	0.022MF	50V	Ceramic	
C133	QCF31HP-223	0.022MF	50V	Ceramic	
C134	QCF31HP-223	0.022MF	50V	Ceramic	
C135	QCF31HP-223	0.022MF	50V	Ceramic	
C136	QCF31HP-223	0.022MF	50V	Ceramic	
C137	QCF31HP-223	0.022MF	50V	Ceramic	
C139	QCS31HJ-121	120PF	50V	Ceramic	F
C139	QCS31HJ-121	120PF	50V	Ceramic	G
C139	QCS31HJ-121	120PF	50V	Ceramic	H
C139	QCS31HJ-470	47PF	50V	Ceramic	I
C140	QET61HM-225	2.2MF	50V	Electro	
C141	QCF31HP-223	0.022MF	50V	Ceramic	
C142	QET61HM-105	1MF	50V	Electro	
C143	QCF31HP-223	0.022MF	50V	Ceramic	

For Service Manuals Contact
MAURITRON TECHNICAL SERVICES
 8 Cherry Tree Rd, Chinnor
 Oxon OX9 4QY
 Tel: 01844-351694 Fax: 01844-352554
 Email: enquiries@mairitron.co.uk

R-X500B

Capacitors

Item No.	Part Number	Description			□
C144	QETC1AM-227	220MF	10V	Electro	
C145	QCF31HP-223	0.022MF	50V	Ceramic	
C146	QETC1CM-476	47MF	16V	Electro	
C147	QCF31HP-223	0.022MF	50V	Ceramic	
C148	QCF31HP-223	0.022MF	50V	Ceramic	
C149	QCF31HP-223	0.022MF	50V	Ceramic	
C150	QET61HM-105	1MF	50V	Electro	
C151	QCY31HK-102	1000PF	50V	Ceramic	
C161	QET61EM-106	10MF	25V	Electro	I
C171	QFN31HK-473	0.047MF	50V	Mylar	
C172	QET61EM-106	10MF	25V	Electro	
C173	QCS31HJ-331	330PF	50V	Ceramic	I
C173	QCS31HJ-391	390PF	50V	Ceramic	H
C173	QCS31HJ-681	680PF	50V	Ceramic	F
C173	QCS31HJ-681	680PF	50V	Ceramic	G
C174	QCS31HJ-331	330PF	50V	Ceramic	I
C174	QCS31HJ-391	390PF	50V	Ceramic	H
C174	QCS31HJ-681	680PF	50V	Ceramic	F
C174	QCS31HJ-681	680PF	50V	Ceramic	G
C175	QET61HM-475	4.7MF	50V	Electro	
C176	QET61HM-475	4.7MF	50V	Electro	
C177	QET61HM-105	1MF	50V	Electro	
C178	QET61HM-105	1MF	50V	Electro	
C179	QEN61HM-474	0.47MF	50V	Non Pole	
C180	QEN61HM-105	1MF	50V	Non Pole	
C181	QETC1CM-107	100MF	16V	Electro	
C201	QCF31HP-223	0.022MF	50V	Ceramic	
C202	QCS31HJ-561	560PF	50V	Ceramic	
C203	QCF31HP-223	0.022MF	50V	Ceramic	
C204	QCC31EM-473	0.047MF	25V	Ceramic	
C206	ENZ1003-006			Trimmer	
C207	QCT25CH-100	10PF	50V	Ceramic	
C208	ENZ1003-006			Trimmer	
C209	QCT25CH-221	220PF	50V	Ceramic	
C210	QCT25CH-221	220PF	50V	Ceramic	
C211	QCT25CH-560	56PF	50V	Ceramic	
C212	QCF31HP-223	0.022MF	50V	Ceramic	
C226	QCS31HJ-270	27PF	50V	Ceramic	
C229	ENZ1003-006			Trimmer	
C229	ENZ1003-006			Trimmer	
C241	QCY31HK-102	1000PF	50V	Ceramic	
C242	QCF31HP-223	0.022MF	50V	Ceramic	
C244	QCF31HP-223	0.022MF	50V	Ceramic	
C245	QET61EM-106	10MF	25V	Electro	
C246	QCF31HP-223	0.022MF	50V	Ceramic	
C247	QCS31HJ-121	120PF	50V	Ceramic	
C248	QCY31HK-102	1000PF	50V	Ceramic	
C250	QFN31HK-103	0.01MF	50V	Mylar	
C251	QFN31HK-473	0.047MF	50V	Mylar	
C252	QFN31HK-103	0.01MF	50V	Mylar	
C253	QCF31HP-223	0.022MF	50V	Ceramic	
C254	QETC1CM-476	47MF	16V	Electro	
C255	QCF31HP-223	0.022MF	50V	Ceramic	
C256	QET61HM-475	4.7MF	50V	Electro	
C257	QET61HM-105	1MF	50V	Electro	
C258	QCF31HP-223	0.022MF	50V	Ceramic	
C259	QET61HM-475	4.7MF	50V	Electro	
C260	QCF31HP-223	0.022MF	50V	Ceramic	
C261	QCF31HP-223	0.022MF	50V	Ceramic	
C451	QCS31HJ-331	330PF	50V	Ceramic	
C452	QETC0JM-227	220MF	6.3V	Electro	
C461	QEN61HM-225	2.2MF	50V	Non Pole	
C462	QCY31HK-102	1000PF	50V	Ceramic	
C463	QETC1CM-476	47MF	16V	Electro	
C481	QCS31HJ-470	47PF	50V	Ceramic	
C482	QCF31HP-223	0.022MF	50V	Ceramic	
C483	QCF31HP-223	0.022MF	50V	Ceramic	
C484	QCS31HJ-470	47PF	50V	Ceramic	

Capacitors

Item No.	Part Number	Description			□
C485	QCF31HP-223	0.022MF	50V	Ceramic	
C486	QCF31HP-223	0.022MF	50V	Ceramic	
C487	QET61HM-474	0.47MF	50V	Electro	

Resistors

Item No.	Part Number	Description			□
R101	QRD141J-473S	47K	1/4W	Carbon	
R102	QRD141J-104S	100K	1/4W	Carbon	
R103	QRD141J-220S	220	1/4W	Carbon	F
R103	QRD141J-220S	22	1/4W	Carbon	G
R103	QRD141J-220S	22	1/4W	Carbon	H
R103	QRD141J-470S	47	1/4W	Carbon	I
R104	QRD141J-470S	47	1/4W	Carbon	
R105	QRD141J-473S	47K	1/4W	Carbon	
R107	QRD141J-221S	220	1/4W	Carbon	
R108	QRD141J-221S	47K	1/4W	Carbon	
R109	QRD141J-332S	3.3K	1/4W	Carbon	
R110	QRD141J-223S	22K	1/4W	Carbon	
R111	QRD141J-102S	1K	1/4W	Carbon	
R112	QRD141J-272S	2.7K	1/4W	Carbon	
R113	QRD141J-222S	2.2K	1/4W	Carbon	
R114	QRD141J-221S	220	1/4W	Carbon	
R115	QRD141J-331S	330	1/4W	Carbon	
R115	QRD141J-331S	330	1/4W	Carbon	
R116	QRD141J-104S	100K	1/4W	Carbon	
R116	QRD141J-104S	100K	1/4W	Carbon	
R117	QRD141J-682S	6.8K	1/4W	Carbon	
R118	QRD141J-103S	10K	1/4W	Carbon	
R119	QRD141J-222S	2.2K	1/4W	Carbon	
R120	QRD141J-102S	1K	1/4W	Carbon	
R121	QRD141J-472S	4.7K	1/4W	Carbon	
R122	QRD141J-104S	100K	1/4W	Carbon	
R123	QRD141J-331S	330	1/4W	Carbon	
△ R124	QRD145J-560S	56	1/4W	Unf. Carbon	
R125	QRD141J-223S	22K	1/4W	Carbon	
△ R131	QRD145J-560S	56	1/4W	Unf. Carbon	
R132	QRD141J-181S	180	1/4W	Carbon	
R133	QRD141J-331S	330	1/4W	Carbon	
R134	QRD141J-331S	330	1/4W	Carbon	
R135	QRD141J-331S	330	1/4W	Carbon	
R136	QRD141J-331S	330	1/4W	Carbon	
R137	QRD141J-103S	10K	1/4W	Carbon	
R139	QRD141J-391S	390	1/4W	Carbon	
R140	QRD141J-153S	15K	1/4W	Carbon	
R141	QRD141J-332S	3.3K	1/4W	Carbon	
△ R142	QRD145J-680S	68	1/4W	Unf. Carbon	F
△ R142	QRD145J-680S	68	1/4W	Unf. Carbon	G
△ R142	QRZ0062-680	68	1/4W	Fusible	H
△ R142	QRZ0062-680	68	1/4W	Fusible	I
R143	QRD141J-223S	22K	1/4W	Carbon	
R144	QVP4A0B-103	10K	0.1W	Variable	
R145	QRD141J-332S	3.3K	1/4W	Carbon	
R146	QVP4A0B-473	10K	0.1W	Variable	
R147	QRD141J-104S	100K	1/4W	Carbon	
R161	QRD141J-103S	10K	1/4W	Carbon	
R171	QVP4A0B-473	47K	0.1W	Variable	
R173	QRD141J-114S	110K	1/4W	Carbon	F
R173	QRD141J-114S	110K	1/4W	Carbon	G
R173	QRD141J-114S	110K	1/4W	Carbon	I
R173	QRD141J-134S	130K	1/4W	Carbon	H

△ : Safety Parts

Resistors

Item No.	Part Number	Description			□
R174	QRD141J-114S	110K	¼W	Carbon	F
R174	QRD141J-114S	110K	¼W	Carbon	G
R174	QRD141J-114S	110K	¼W	Carbon	I
R174	QRD141J-134S	130K	¼W	Carbon	H
R175	QRD141J-154S	150K	¼W	Carbon	F
R175	QRD141J-154S	150K	¼W	Carbon	G
R175	QRD141J-184S	180K	¼W	Carbon	H
R175	QRD141J-184S	180K	¼W	Carbon	I
R176	QRD141J-154S	150K	¼W	Carbon	F
R176	QRD141J-154S	150K	¼W	Carbon	G
R176	QRD141J-184S	180K	¼W	Carbon	H
R176	QRD141J-184S	180K	¼W	Carbon	I
R177	QRD141J-332S	3.3K	¼W	Carbon	
R178	QRD141J-332	3.3K	¼W	Carbon	
R179	QRD141J-682S	6.8K	¼W	Carbon	
R180	QRD141J-682S	6.8K	¼W	Carbon	
R181	QRD141J-332S	3.3K	¼W	Carbon	
△ R182	QRD145J-680S	68	¼W	Unf. Carbon	F
△ R182	QRD145J-680S	68	¼W	Unf. Carbon	G
△ R182	QRZ0062-680	68	¼W	Fusible	H
△ R182	QRD0062-680	68	¼W	Fusible	I
R183	QRD141J-103S	10K	¼W	Carbon	
R184	QRD141J-103S	10K	¼W	Carbon	
R185	QRD141J-104S	100K	¼W	Carbon	
R201	QRD141J-331S	330	¼W	Carbon	
R202	QRD141J-471S	470	¼W	Carbon	
R204	QRD141J-103S	10K	¼W	Carbon	
R206	QRD141J-473S	47K	¼W	Carbon	
R207	QRD141J-472S	4.7K	¼W	Carbon	
R242	QRD141J-331S	330	¼W	Carbon	
R243	QRD141J-102S	1K	¼W	Carbon	
R244	QRD141J-221S	220	¼W	Carbon	
R246	QRD141J-682S	6.8K	¼W	Carbon	
R247	QRD141J-332S	3.3K	¼W	Carbon	
△ R248	QRD145J-680	68	¼W	Unf. Carbon	F
△ R248	QRD145J-680S	68	¼W	Unf. Carbon	G
△ R248	QRZ0062-680	68	¼W	Fusible	H
△ R248	QRZ0062-680	68	¼W	Fusible	I
R249	QRD141J-103S	10K	¼W	Carbon	
R250	QRD141J-103S	10K	¼W	Carbon	
R251	QRD141J-221S	220	¼W	Carbon	
R252	QVP4A0B-103	10K	0.1W	Variable	
R253	QRD141J-332S	3.3K	¼W	Carbon	
R451	QRD148J-275S	2.7M	¼W	Carbon	
R452	QRD141J-104S	100K	¼W	Carbon	
R453	QRD141J-104S	100K	¼W	Carbon	
R454	QRD141J-104S	100K	¼W	Carbon	
R455	QRD141J-101S	100	¼W	Carbon	
R456	QRD141J-473S	47K	¼W	Carbon	
R461	QRD141J-222S	2.2K	¼W	Carbon	
R462	QRD141J-102S	1K	¼W	Carbon	
R463	QRD141J-152S	1.5K	¼W	Carbon	
R464	QRD141J-271S	270	¼W	Carbon	
R465	QRD141J-472S	4.7K	¼W	Carbon	
△ R466	QRD145J-680S	68	¼W	Unf. Carbon	F
△ R466	QRD145-680S	68	¼W	Unf. Carbon	G
△ R466	QRZ0062-680	68	¼W	Fusible	H
△ R466	QRZ0062-680	68	¼W	Fusible	I
R481	QRD141J-104S	100K	¼W	Carbon	
R482	QRD141J-221S	220	¼W	Carbon	
R483	QRD141J-332S	3.3K	¼W	Carbon	
R484	QRD141J-472S	4.7K	¼W	Carbon	
R485	QRD141J-223S	22K	¼W	Carbon	
R486	QRD141J-472S	4.7K	¼W	Carbon	
R487	QRD141J-223S	22K	¼W	Carbon	
R489	QRD141J-473S	47K	¼W	Carbon	
R490	QRD141J-103S	10K	¼W	Carbon	
R491	QRD141J-332S	3.3K	¼W	Carbon	
R492	QRD141J-104S	100K	¼W	Carbon	

Resistors

Item No.	Part Number	Description			□
R493	QRD141J-682S	6.8K	¼W	Carbon	
R494	QRD141J-473S	47K	¼W	Carbon	
R496	QRD141J-123S	12K	¼W	Carbon	H
R496	QRD141J-123S	12K	¼W	Carbon	I

Others

Item No.	Part Number	Description		□
	EMB01YV-201A	Antenna Terminal		I
	E03572-016	Terminal Board		F
	E03572-016	Terminal Board		G
	E03572-016	Terminal Board		H
	E67764-002	Terminal Ass'y		
	E67764-002	Terminal Ass'y		
	E67764-002	Terminal Ass'y		
	E24693-103	Circuit Board		
	E70859-001	Earth Plate		
	E69328-001	Shield Cover		
L161	EQF0102-001	Filter		I
P101	E04365-003	F.W. Socket		
P102	E04365-004	Jumper Socket		
P103	QMV5005-003	3P Plug Ass'y		
BF101	EQF0101-005	Filter		
CF131	ECB2123-002R	Ceramic Filter		I
CF132	ECB2123-003R	Ceramic Filter		
CF133	ECB2123-003R	Ceramic Filter		
CF171	ECX0000-456KS	Resonator		
CF241	ECB1560-001	Ceramic Filter		
LF171	EQF0101-002	Filter		
LF171	EQF0101-002	Filter		
LF172	EQF0101-006	Filter		
LF173	EQF0101-006	Filter		
SW401	QSS1201-039	Slide Switch		B

△ : Safety Parts

The column marked with □ indicates the Area.

Parts without character in the column are used commonly regardless of delivery area.

3-(5) ENC-009 Amp P.C. Board Ass'y

Note: ENC-009 varies according to the areas employed. See note(1) when placing on order.

Note (1)

P.C. Board Ass'y	Designated Areas
ENC-009 <input type="checkbox"/>	U.S.A., Canada, U.S. Military Market & Other Countries
ENC-009 <input type="checkbox"/>	Europe, Australia & U.K.
ENC-009 <input type="checkbox"/>	West Germany

For Service Manuals Contact
MAURITRON TECHNICAL SERVICES
 8 Cherry Tree Rd, Chinnor
 Oxon OX9 4QY
 Tel: 01844-351694 Fax: 01844-352554
 Email: enquiries@mauritron.co.uk

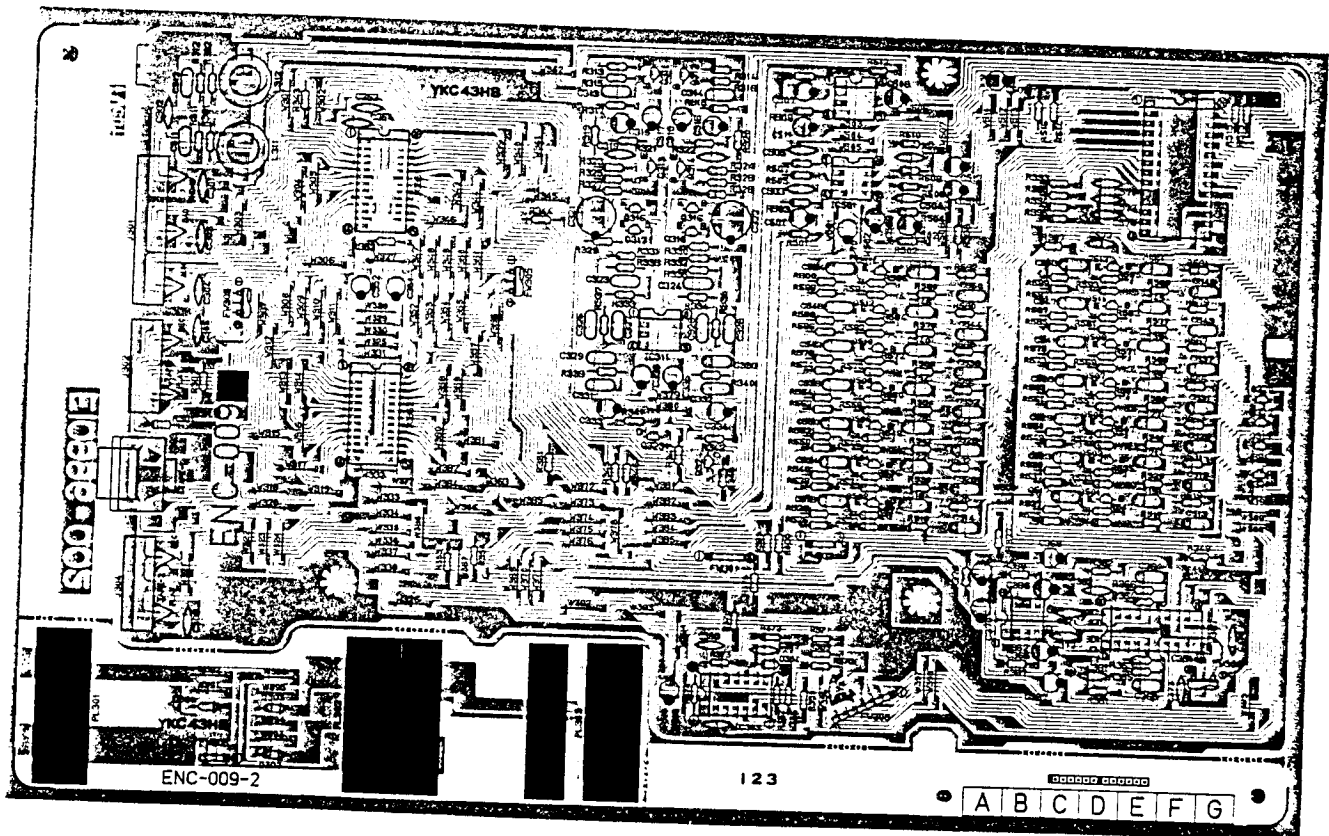

Transistors

Item No.	Part Number	Description		<input type="checkbox"/>
			Maker	
Q311	2SD655(E,F)	Silicon	Hitachi	
Q311	2SD655(E,F)	Silicon	Hitachi	
Q311	2SD655(E,F)	Silicon	Hitachi	
Q312	2SD655(E,F)	Silicon	Hitachi	
Q312	2SD655(E,F)	Silicon	Hitachi	
Q312	2SD655(E,F)	Silicon	Hitachi	
Q313	2SD655(E,F)	Silicon	Hitachi	
Q313	2SD655(E,F)	Silicon	Hitachi	
Q313	2SD655(E,F)	Silicon	Hitachi	
Q314	2SD655(E,F)	Silicon	Hitachi	
Q314	2SD655(E,F)	Silicon	Hitachi	
Q315	2SC2240(A,B)	Silicon	Toshiba	
Q316	2SC2240(A,B)	Silicon	Toshiba	
Q317	2SC2240(A,B)	Silicon	Toshiba	

Transistors

Item No.	Part Number	Description		<input type="checkbox"/>
			Maker	
Q318	2SC2240(A,B)	Silicon	Toshiba	
Q319	DTC144N	Silicon		
Q320	DTA114YN	Silicon		
Q321	DTC144N	Silicon		
Q322	DTA114YN	Silicon		
Q323	2SK163(L2,M1)	F.E.T.		
Q323	2SK163(L2,M1)	F.E.T.		
Q323	2SK163(L2,M1)	F.E.T.		
Q324	2SK163(L2,M1)	F.E.T.		
Q324	2SK163(L2,M1)	F.E.T.		
Q324	2SK163(L2,M1)	F.E.T.		
Q501	2SC2240(GR,BL)	Silicon	Toshiba	
Q502	2SC2240(GR,BL)	Silicon	Toshiba	
Q503	2SC2240(GR,BL)	Silicon	Toshiba	
Q504	2SC2240(GR,BL)	Silicon	Toshiba	

Transistors

Item No.	Part Number	Description		□
			Maker	
Q505	2SC2240(GR,BL)	Silicon	Toshiba	
Q506	2SC2240(GR,BL)	Silicon	Toshiba	
Q507	2SC2240(GR,BL)	Silicon	Toshiba	
Q508	2SC2240(GR,BL)	Silicon	Toshiba	
Q509	2SC2240(GR,BL)	Silicon	Toshiba	
Q510	2SC2240(GR,BL)	Silicon	Toshiba	
Q511	2SC2240(GR,BL)	Silicon	Toshiba	
Q512	2SC2240(GR,BL)	Silicon	Toshiba	
Q513	2SC2240(GR,BL)	Silicon	Toshiba	
Q514	2SC2240(GR,BL)	Silicon	Toshiba	

ICs

Item No.	Part Number	Description		□
			Maker	
IC311	NJM4560D-X		Dainichi	
IC351	TC9164N		Toshiba	
IC352	TC9163N		Toshiba	
IC361	TC9177P		Toshiba	
IC362	NJM4560D-X		Dainichi	
IC363	TC4069UBP		Toshiba	
IC501	NJM4560D-X		Dainichi	
IC502	NJM4560D-X		Dainichi	
IC503	LC7520		Sanyo	

Diodes

Item No.	Part Number	Description		□
			Maker	
D301	RD3.9EB2	Zener	NEC	
D302	RD3.9EB2	Zener	NEC	
D303	RD3.9EB2	Zener	NEC	
D304	RD3.9EB2	Zener	NEC	
D305	RD3.9EB2	Zener	NEC	
D306	RD3.9EB2	Zener	NEC	
D307	RD3.9EB2	Zener	NEC	
D308	RD3.9EB2	Zener	NEC	
D309	RD3.9EB2	Zener	NEC	

Coils

Item No.	Part Number	Description		□
			Maker	
L311	EQL0111-151	Inductor		F
L312	EQL0111-151	Inductor		F

Capacitors

Item No.	Part Number	Description		□
			Maker	
C301	QCF31HP-223	0.022MF	50V Ceramic	
C303	QCF31HP-223	0.022MF	50V Ceramic	
C304	QCF31HP-223	0.022MF	50V Ceramic	
C305	QCF31HP-223	0.022MF	50V Ceramic	
C306	QCF31HP-223	0.022MF	50V Ceramic	
C311	QFP31HJ-101	100PF	50V Poly	
C312	QFP31HJ-101	100PF	50V Poly	
C313	QFN31HK-103	0.01MF	50V Mylar	
C314	QFN31HK-103	0.01MF	50V Mylar	
C315	QEB61HM-105	1MF	50V L.L.C.E.	
C316	QEB61HM-105	1MF	50V L.L.C.E.	D
C317	QEB61HM-105	1MF	50V L.L.C.E.	
C318	QEB61HM-105	1MF	50V L.L.C.E.	
C319	QCS31HJ-270	27PF	50V Ceramic	
C319	QCS31HJ-270	27PF	50V Ceramic	

Capacitors

Item No.	Part Number	Description		□
			Maker	
C319	QCS31HJ-471	470PF	50V Ceramic	F
C320	QCS31HJ-270	27PF	50V Ceramic	D
C320	QCS31HJ-270	27PF	50V Ceramic	E
C320	QCS31HJ-471	470PF	50V Ceramic	F
C321	QETB0JM-108	1000MF	6.3V Electro	
C322	QETB0JM-108	1000MF	6.3V Electro	
C323	QFN31HK-392	3900PF	50V Mylar	
C324	QFN31HK-392	3900PF	50V Mylar	
C325	QFN31HJ-153	0.015MF	50V Mylar	
C326	QFN31HJ-153	0.015MF	50V Mylar	
C327	QFN31HJ-272	2700MF	50V Mylar	
C328	QFN31HJ-272	2700MF	50V Mylar	
C329	QFN31HJ-472	4700MF	50V Mylar	
C330	QFN31HJ-472	4700MF	50V Mylar	
C331	QFP31HJ-331	330PF	50V Poly	
C332	QFP31HJ-331	330PF	50V Poly	
C333	QETC1HM-475	4.7MF	50V Electro	
C334	QETC1HM-475	4.7MF	50V Electro	
C335	QETC1EM-476	47MF	25V Electro	
C336	QETC1EM-476	47MF	25V Electro	
C337	QCF31HP-223	0.022MF	50V Ceramic	
C338	QCF31HP-223	0.022MF	50V Ceramic	
C351	QETC1EM-476	47MF	25V Electro	
C352	QETC1EM-476	47MF	25V Electro	
C353	QCF31HP-223	0.022MF	50V Ceramic	
C354	QCF31HP-223	0.022MF	50V Ceramic	
C357	QCS31HJ-101	100PF	50V Ceramic	
C358	QCS31HJ-101	100PF	50V Ceramic	
C359	QCS31HJ-101	100PF	50V Ceramic	
C361	QCS31HJ-221	220PF	50V Ceramic	
C362	QCS31HJ-221	220PF	50V Ceramic	
C363	QFN31HK-333	0.033MF	50V Mylar	
C364	QFN31HK-333	0.033MF	50V Mylar	
C365	QETC1HM-105	1MF	50V Electro	
C366	QETC1EM-105	1MF	50V Electro	
C367	QETC1EM-106	10MF	25V Electro	
C368	QETC1EM-106	10MF	25V Electro	
C369	QETC1EM-476	47MF	25V Electro	
C370	QETC1EM-476	47MF	25V Electro	
C371	QCF31HP-223	0.022MF	50V Ceramic	
C372	QCF31HP-223	0.022MF	50V Ceramic	
C373	QCS31HJ-5R0	5.0PF	50V Ceramic	
C374	QCS31HJ-5R0	5.0PF	50V Ceramic	
C375	QCS31HJ-5R0	5.0PF	50V Ceramic	
C376	QCS31HJ-5R0	5.0PF	50V Ceramic	
C377	QCS31HJ-101	100PF	50V Ceramic	
C378	QCS31HJ-101	100PF	50V Ceramic	
C379	QCS31HJ-101	100PF	50V Ceramic	
C380	QCS31HJ-101	100PF	50V Ceramic	
C381	QETC1EM-106	10MF	25V Electro	
C391	QCS31HJ-101	100PF	50V Ceramic	
C392	QCS31HJ-101	100PF	50V Ceramic	
C501	QETC1HM-225	2.2MF	50V Electro	
C502	QETC1HM-225	2.2MF	50V Electro	
C503	QCS31HJ-270	27PF	50V Ceramic	
C503	QCS31HJ-270	27PF	50V Ceramic	
C503	QCS31HJ-270	27PF	50V Ceramic	
C503	QCS31HJ-471	470PF	50V Ceramic	
C503	QCS31HJ-471	470PF	50V Ceramic	
C504	QCS31HJ-270	27PF	50V Ceramic	
C504	QCS31HJ-270	27PF	50V Ceramic	
C504	QCS31HJ-270	27PF	50V Ceramic	
C504	QCS31HJ-270	27PF	50V Ceramic	
C504	QCS31HJ-471	470PF	50V Ceramic	
C504	QCS31HJ-471	470PF	50V Ceramic	
C505	QCS31HJ-470	47PF	50V Ceramic	
C506	QCS31HJ-470	47PF	50V Ceramic	
C507	QETC1HM-475	4.7MF	50V Electro	
C508	QETC1HM-475	4.7MF	50V Electro	

For Service Manuals Contact
MAURITRON TECHNICAL SERVICES
 8 Cherry Tree Rd, Chinnor
 Oxon OX9 4QY
 Tel: 01844-351694 Fax: 01844-352554
 Email: enquiries@mauratron.co.uk

R-X500B

Capacitors

Item No.	Part Number	Description			□
C509	QETC1HM-475	4.7MF	50V	Electro	
C510	QETC1HM-475	4.7MF	50V	Electro	
C511	QETC1HM-475	4.7MF	50V	Electro	
C512	QETC1HM-475	4.7MF	50V	Electro	
C513	QFV71HJ-474	0.47MF	50V	T. Film	
C514	QFV71HJ-474	0.47MF	50V	T. Film	
C515	QFV71HJ-184	0.18MF	50V	T. Film	
C516	QFV71HJ-184	0.18MF	50V	T. Film	
C517	QFV71HJ-333	0.033MF	50V	T. Film	
C518	QFV71HJ-333	0.033MF	50V	T. Film	
C519	QFV71HJ-184	0.18MF	50V	T. Film	
C520	QFV71HJ-184	0.18MF	50V	T. Film	
C521	QFV71HJ-154	0.15MF	50V	T. Film	
C522	QFV71HJ-154	0.15MF	50V	T. Film	
C523	QFV71HJ-273	0.027MF	50V	T. Film	
C524	QFV71HJ-273	0.027MF	50V	T. Film	
C525	QFV71HJ-823	0.082MF	50V	T. Film	
C526	QFV71HJ-823	0.082MF	50V	T. Film	
C527	QFV71HJ-683	0.068MF	50V	T. Film	
C528	QFV71HJ-683	0.068MF	50V	T. Film	
C529	QFN31HJ-123	0.012MF	50V	Mylar	
C530	QFN31HJ-123	0.012MF	50V	Mylar	
C531	QFV71HJ-333	0.033MF	50V	T. Film	
C532	QFV71HJ-333	0.033MF	50V	T. Film	
C533	QFV71HJ-273	0.027MF	50V	T. Film	
C534	QFV71HJ-273	0.027MF	50V	T. Film	
C535	QFN31HJ-562	5600PF	50V	Mylar	
C536	QFN31HJ-562	5600PF	50V	Mylar	
C537	QFN31HJ-123	0.012MF	50V	Mylar	
C538	QFN31HJ-123	0.012MF	50V	Mylar	
C539	QFN31HJ-103	0.01MF	50V	Mylar	
C540	QFN31HJ-103	0.01MF	50V	Mylar	
C541	QFN31HJ-392	3900MF	50V	Mylar	
C542	QFN31HJ-392	3900MF	50V	Mylar	
C543	QFN31HJ-472	4700MF	50V	Mylar	
C544	QFN31HJ-472	4700MF	50V	Mylar	
C545	QFN31HJ-392	3900MF	50V	Mylar	
C546	QFN31HJ-392	3900MF	50V	Mylar	
C547	QFP31HJ-681	680PF	50V	Poly	
C548	QFP31HJ-681	680PF	50V	Poly	
C549	QFN31HJ-182	1800PF	50V	Mylar	
C550	QFN31HJ-182	1800PF	50V	Mylar	
C551	QFN31HJ-182	1800MF	50V	Mylar	
C552	QFN31HJ-182	1800MF	50V	Mylar	
C553	QFP31HJ-331	330PF	50V	Poly	
C554	QFP31HJ-331	330PF	50V	Poly	
C569	QETC1EM-476	47MF	25V	Electro	
C570	QETC1EM-476	47MF	25V	Electro	
C571	QCF31HP-223	0.022MF	50V	Ceramic	
C572	QCF31HP-223	0.022MF	50V	Ceramic	
C573	QCF31HP-223	0.022MF	50V	Ceramic	
C574	QCF31HP-223	0.022MF	50V	Ceramic	

Resistors

Item No.	Part Number	Description			□
R317	QRD141J-153S	15K	½W	Carbon	
R318	QRD141J-153S	15K	½W	Carbon	
R319	QRD148J-5R6S	5.6	½W	Carbon	
R320	QRD148J-5R6S	5.6	½W	Carbon	
R321	QRD141J-104S	100K	½W	Carbon	
C322	QRD141J-104S	100K	½W	Carbon	
C323	QRD141J-181S	180	½W	Carbon	
R324	QRD141J-181S	180	½W	Carbon	
R325	QRD148J-200S	20	½W	Carbon	
R325	QRD148J-200S	20	½W	Carbon	
R325	QRD148J-200S	20	½W	Carbon	
R326	QRD148J-200S	20	½W	Carbon	
R326	QRD148J-200S	20	½W	Carbon	
R326	QRD148J-200S	20	½W	Carbon	
R327	QRD141J-332S	3.3K	½W	Carbon	
R328	QRD141J-332S	3.3K	½W	Carbon	
R329	QRD141J-333S	33K	½W	Carbon	
R330	QRD141J-333S	33K	½W	Carbon	
R331	QRD141J-103S	10K	½W	Carbon	
R332	QRD141J-103S	10K	½W	Carbon	
R333	QRD141J-103S	10K	½W	Carbon	
R334	QRD141J-103S	10K	½W	Carbon	
R335	QRD141J-270S	27	½W	Carbon	
R336	QRD141J-270S	27	½W	Carbon	
R337	QRD141J-184S	180K	½W	Carbon	
R338	QRD141J-184S	180K	½W	Carbon	
R339	QRD141J-153S	15K	½W	Carbon	
R340	QRD141J-153S	15K	½W	Carbon	
R341	QRD141J-472S	4.7K	½W	Carbon	
R342	QRD141J-472S	4.7K	½W	Carbon	
R343	QRD141J-104S	100K	½W	Carbon	
R344	QRD141J-104S	100K	½W	Carbon	
△ R345	QRD145J-680S	68	½W	Unf. Carbon	D
△ R345	QRZ0062-680	68	½W	Fusible	E
△ R345	QRZ0062-680	68	½W	Fusible	F
△ R346	QRD145J-680S	68	½W	Unf. Carbon	D
△ R346	QRZ0062-680	68	½W	Fusible	E
△ R346	QRZ0062-680	68	½W	Fusible	F
R347	QRD141J-473S	47K	½W	Carbon	
R348	QRD141J-473S	47K	½W	Carbon	
R349	QRD141J-104S	100K	½W	Carbon	
R351	QRD141J-271S	270	½W	Carbon	
R352	QRD141J-271S	270	½W	Carbon	
R353	QRD141J-104S	100K	½W	Carbon	
R354	QRD141J-104S	100K	½W	Carbon	
R355	QRD141J-473S	47K	½W	Carbon	
R356	QRD141J-473S	47K	½W	Carbon	
R357	QRD141J-473S	47K	½W	Carbon	
R361	QRD141J-273S	27K	½W	Carbon	
R362	QRD141J-273S	27K	½W	Carbon	
R363	QRD141J-563S	56K	½W	Carbon	
R364	QRD141J-563S	56K	½W	Carbon	
R365	QRD141J-105S	1M	½W	Carbon	
R366	QRD141J-105S	1M	½W	Carbon	
R367	QRD141J-105S	1M	½W	Carbon	
R368	QRD141J-105S	1M	½W	Carbon	
R369	QRD141J-473S	47K	½W	Carbon	
R370	QRD141J-473S	47K	½W	Carbon	
R371	QRD141J-473S	47K	½W	Carbon	
R372	QRD141J-472S	4.7K	½W	Carbon	
R373	QRD148J-911S	910	½W	Carbon	
R374	QRD141J-473S	47K	½W	Carbon	
R375	QRD141J-101S	100	½W	Carbon	
△ R377	QRD145J-680S	68	½W	Unf. Carbon	D
△ R377	QRZ0062-680	68	½W	Fusible	E
△ R377	QRZ0062-680	68	½W	Fusible	F
△ R378	QRD145J-680S	68	½W	Unf. Carbon	D
△ R378	QRZ0062-680	68	½W	Fusible	E
△ R378	QRZ0062-680	68	½W	Fusible	F
R381	QRD141J-152S	1.5K	½W	Carbon	

Resistors

Item No.	Part Number	Description			□
R301	QRD141J-124S	120K	½W	Carbon	E
R301	QRD141J-124S	120K	½W	Carbon	F
R302	QRD141J-124S	120K	½W	Carbon	F
R302	QRD141J-124S	120K	½W	Carbon	F
R311	QRD141J-471S	470	½W	Carbon	
R312	QRD141J-471S	470	½W	Carbon	
R313	QRD141J-104S	100K	½W	Carbon	
R314	QRD141J-104S	100K	½W	Carbon	
R315	QRD141J-101S	100	½W	Carbon	
R316	QRD141J-101S	100	½W	Carbon	

△: Safety Parts

Resistors

Item No.	Part Number	Description			□
R382	QRD141J-152S	1.5K	¼W	Carbon	
R391	QRD141J-473S	47K	¼W	Carbon	
R392	QRD141J-473S	47K	¼W	Carbon	
R393	QRD141J-272S	2.7K	¼W	Carbon	
R394	QRD141J-682S	6.8K	¼W	Carbon	
R395	QRD141J-682S	6.8K	¼W	Carbon	
R396	QRD141J-272S	2.7K	¼W	Carbon	
R397	QRD141J-101S	100	¼W	Carbon	
R398	QRD141J-101S	100	¼W	Carbon	
△ R399	QRD145J-220S	22	¼W	Unf. Carbon	D
△ R399	QRZ0062-220	22	¼W	Fusible	E
△ R399	QRZ0062-220	22	¼W	Fusible	F
△ R400	QRD145J-220S	22	¼W	Unf. Carbon	D
△ R400	QRZ0062-220	22	¼W	Fusible	E
△ R400	QRZ0062-220	22	¼W	Fusible	F
R501	QRD141J-104S	100K	¼W	Carbon	
R502	QRD141J-104S	100K	¼W	Carbon	
R503	QRD141J-104S	100K	¼W	Carbon	
R504	QRD141J-104S	100K	¼W	Carbon	
R505	QRD141J-270S	27	¼W	Carbon	
R506	QRD141J-270S	27	¼W	Carbon	
R507	QRD141J-113S	11K	¼W	Carbon	
R508	QRD141J-113S	11K	¼W	Carbon	
R509	QRD141J-113S	11K	¼W	Carbon	
R510	QRD141J-113S	11K	¼W	Carbon	
R511	QRD141J-104S	100K	¼W	Carbon	
R512	QRD141J-104S	100K	¼W	Carbon	
R513	QRD141J-114S	100K	¼W	Carbon	
R514	QRD141J-114S	100K	¼W	Carbon	
R515	QRD141J-114S	110K	¼W	Carbon	
R516	QRD141J-114S	110K	¼W	Carbon	
R517	QRD141J-101S	100	¼W	Carbon	
R518	QRD141J-101S	100	¼W	Carbon	
R519	QRD141J-105S	1M	¼W	Carbon	
R520	QRD141J-105S	1M	¼W	Carbon	
R521	QRD141J-681S	680	¼W	Carbon	
R522	QRD141J-681S	680	¼W	Carbon	
R523	QRD141J-123S	12K	¼W	Carbon	
R524	QRD141J-123S	12K	¼W	Carbon	
R525	QRD141J-103S	10K	¼W	Carbon	
R526	QRD141J-103S	10K	¼W	Carbon	
R527	QRD141J-104S	100K	¼W	Carbon	
R528	QRD141J-104S	100K	¼W	Carbon	
R529	QRD141J-470S	47	¼W	Carbon	
R530	QRD141J-470S	47	¼W	Carbon	
R531	QRD141J-105S	1M	¼W	Carbon	
R532	QRD141J-105S	1M	¼W	Carbon	
R533	QRD141J-681S	680	¼W	Carbon	
R534	QRD141J-681S	680	¼W	Carbon	
R535	QRD141J-472S	4.7K	¼W	Carbon	
R536	QRD141J-472S	4.7K	¼W	Carbon	
R537	QRD141J-103S	10K	¼W	Carbon	
R538	QRD141J-103S	10K	¼W	Carbon	
R539	QRD141J-473S	47K	¼W	Carbon	
R540	QRD141J-473S	47K	¼W	Carbon	
R541	QRD141J-151S	150	¼W	Carbon	
R542	QRD141J-151S	150	¼W	Carbon	
R543	QRD141J-105S	1M	¼W	Carbon	
R544	QRD141J-105S	1M	¼W	Carbon	
R545	QRD141J-561S	560	¼W	Carbon	
R546	QRD141J-561S	560	¼W	Carbon	
R547	QRD141J-472S	4.7K	¼W	Carbon	
R548	QRD141J-472S	4.7K	¼W	Carbon	
R549	QRD141J-103S	10K	¼W	Carbon	
R550	QRD141J-103S	10K	¼W	Carbon	
R551	QRD141J-473S	47K	¼W	Carbon	
R552	QRD141J-473S	47K	¼W	Carbon	
R553	QRD141J-101S	100	¼W	Carbon	
R554	QRD141J-101S	100	¼W	Carbon	
R555	QRD141J-105S	1M	¼W	Carbon	

△ : Safety Parts

Resistors

Item No.	Part Number	Description			□
R556	QRD141J-105S	1M	¼W	Carbon	
R557	QRD141J-561S	560	¼W	Carbon	
R558	QRD141J-561S	560	¼W	Carbon	
R559	QRD141J-332S	3.3K	¼W	Carbon	
R560	QRD141J-332S	3.3K	¼W	Carbon	
R561	QRD141J-103S	10K	¼W	Carbon	
R562	QRD141J-103S	10K	¼W	Carbon	
R563	QRD141J-473S	47K	¼W	Carbon	
R564	QRD141J-473S	47K	¼W	Carbon	
R565	QRD141J-470	47	¼W	Carbon	
R566	QRD141J-470S	47	¼W	Carbon	
R567	QRD141J-105S	1M	¼W	Carbon	
R568	QRD141J-105S	1M	¼W	Carbon	
R569	QRD141J-681S	680	¼W	Carbon	
R570	QRD141J-681S	680	¼W	Carbon	
R571	QRD141J-472S	4.7K	¼W	Carbon	
R572	QRD141J-472S	4.7K	¼W	Carbon	
R573	QRD141J-103S	10K	¼W	Carbon	
R574	QRD141J-103S	10K	¼W	Carbon	
R575	QRD141J-393S	39K	¼W	Carbon	
R576	QRD141J-393S	39K	¼W	Carbon	
R577	QRD141J-470S	47	¼W	Carbon	
R578	QRD141J-470S	47	¼W	Carbon	
R579	QRD141J-105S	1M	¼W	Carbon	
R580	QRD141J-105S	1M	¼W	Carbon	
R581	QRD141J-681S	680	¼W	Carbon	
R582	QRD141J-681S	680	¼W	Carbon	
R583	QRD141J-472S	4.7K	¼W	Carbon	
R584	QRD141J-472S	4.7K	¼W	Carbon	
R585	QRD141J-103S	10K	¼W	Carbon	
R586	QRD141J-103S	10K	¼W	Carbon	
R587	QRD141J-473S	47K	¼W	Carbon	
R588	QRD141J-473S	47K	¼W	Carbon	
R589	QRD141J-470S	47	¼W	Carbon	
R590	QRD141J-470S	47	¼W	Carbon	
R591	QRD141J-105S	1M	¼W	Carbon	
R592	QRD141J-105S	1M	¼W	Carbon	
R593	QRD141J-561S	560	¼W	Carbon	
R594	QRD141J-561S	560	¼W	Carbon	
R595	QRD141J-472S	4.7K	¼W	Carbon	
R596	QRD141J-472S	4.7K	¼W	Carbon	
R597	QRD141J-103S	10K	¼W	Carbon	
R598	QRD141J-103S	10K	¼W	Carbon	
R599	QRD141J-473S	47K	¼W	Carbon	
R600	QRD141J-473S	47K	¼W	Carbon	

Others

Item No.	Part Number	Description	□
	EMC0589-002	Din Socket	E
	EMC0589-002	Din Socket	F
	EMN00TV-402A	Pin Jack Ass'y	
	EMN00TV-402A	Pin Jack Ass'y	
	EMN00TV-602A	Pin Jack Ass'y	
	E45524-002	Fuse Clip	
	E10996-001	Circuit Board	
	E70225-001	Earth Plate	
	E03532-001	Shield Case	F

△ : Safety Parts

The column marked with □ indicates the Area.

Parts without character in the column are used commonly regardless of delivery area.

4. Packing Materials and Part Numbers

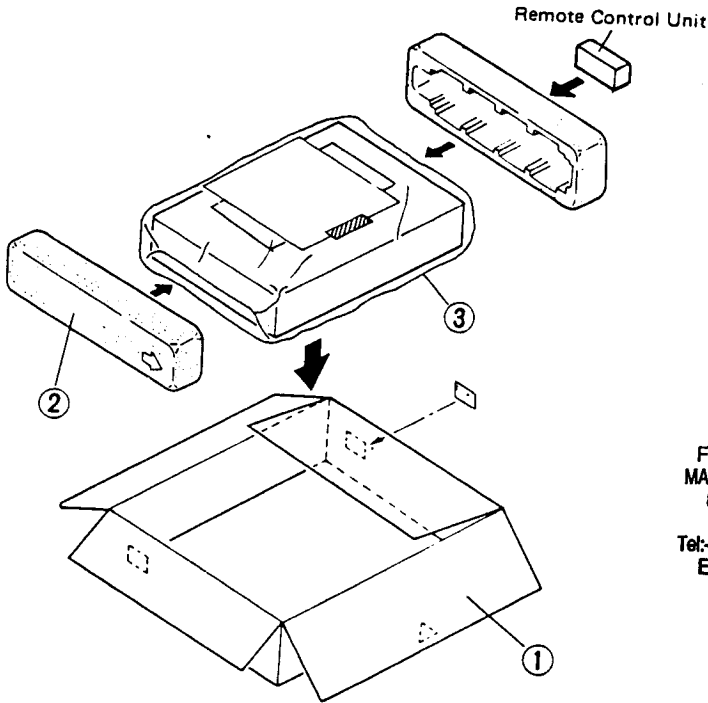

No.	Part Number	Part Name	Areas
1	PK-RX500BE	Packing Case	
2	NZ-RX500BE	Packing Pad	
3	E34033-015	Envelope	Except BS
	E34033-015B	Envelope	BS only

For Service Manuals Contact
MAURITRON TECHNICAL SERVICES
 8 Cherry Tree Rd, Chinnor
 Oxon OX9 4QY
 Tel:- 01844-351694 Fax:- 01844-352554
 Email:- enquiries@mauritron.co.uk

5. Accessories List

Part Number	Part Name	Description	Area
E30580-1189B	Instruction Book		
E30580-1189BBS	Instruction Book		Except BS
E41202-2	Envelope		BS Only
E41202-2B	Envelope		Except BS
EQB4001-008	Bar Antenna Coil		BS Only
E04056	Siemens Plug		
BT20048A	Warranty Card		U, P, PG
BT20046B	Service Information Card		J, P, PG
BT20025G	Warranty Card		J, P, PG
BT20071	Service Center List		C
BT20029C	Warranty Card		C
BT20064	Warranty Card		A
BT20066	EEC Agency		G
BT20060	Warranty Card		G, BS
BT20044D	Safety Instruction Sheet		BS
BT20054-005A	FTZ Information Sheet		J
E6581-4	Envelope		G
E66416-003	Envelope		U, P, PG
E03614-004	Bilt-in Antenna		J, C
E67007-001	Wire Antenna Ass'y		Except G
RM-500	Remote Control		G Only

The Marks for Designated Areas.

- J U.S.A.
- C Canada
- E Europe
- G West Germany
- A Australia
- P, PG U.S. Military Market
- BS U.K.
- U Other Countries